

QST

DEVOTED ENTIRELY TO

AMATEUR RADIO

Published by the American Radio Relay League



AUGUST
1926

25¢

Cunningham

RADIO TUBES

Since 1915—
Standard for all Sets



Dogged Determination

to approach perfection within the narrow confines of these delicate glass enclosures has led up to the present high stage in the development of Cunningham Radio Tubes.

The Cunningham appeal to the radio public always has been, and ever will be, a quality appeal. Performance claims are backed consistently day after day, year after year, by the steady efficient service these tubes render in millions of American receivers.

All Types C-&CX---

In the Orange and Blue Carton

E. J. Cunningham, Inc.

New York

Chicago

San Francisco

Manufactured and sold under rights, patents and inventions owned and / or controlled by Radio Corporation of America

. . . World's largest maker of Neutrodyne Sets endorses this low resistance battery

Here is what this eminent radio engineer says about the importance of battery resistance in radio reception:

"High internal resistance in the 'B' battery current supply cuts down the volume and causes distortion.

"We have found that Ray-O-Vac Batteries have extremely low internal resistance. They give clearer reception because all tones are faithfully reproduced. Better service is obtained from 'B' batteries with low internal resistance because of the absence of noises and because low resistance 'B' batteries keep the audio circuit in a stable condition.

"We are now equipping our research and development and test laboratories with Ray-O-Vac Batteries exclusively, because we have found that they are the best and most economical, convenient sources of supply for plate current. We recommend them to all set owners because of their low internal resistance and long life."



MR. JOSEPH D. R. FREED

President of the Freed-Eisemann Radio Corporation, the world's largest makers of Neutrodyne Radio Receivers. Freed-Eisemann receiving sets have brought pleasure to hundreds of thousands of "listeners-in" all over the world. Read what he says about THIS remarkable dry cell radio battery.

THIS is the highest endorsement any battery can receive, the unqualified recommendation of a leading manufacturer of radio sets. You need a low-resistance battery for transmission as well as reception. The

Ray-O-Vac Battery has the lowest internal resistance of any dry cell battery made, with *staying power* that gives it longer life. Yet it costs no more than ordinary batteries.

The dealers from whom you usually buy can undoubtedly furnish you with Ray-O-Vac radio batteries. If you have any difficulty getting them, write us for the name and address of a nearby dealer or jobber who can supply you.

FRENCH BATTERY COMPANY
Madison, Wisconsin



Ray-O-Vac "B" batteries in all standard sizes, both flat and upright.

Ray-O-Vac "A" batteries recuperate during rest periods, lasting longer and giving excellent reception.

Ray-O-Vac 4½-volt "C" batteries with three variable terminals give voltage adjustments of 1½, 3 and 4½ volts.

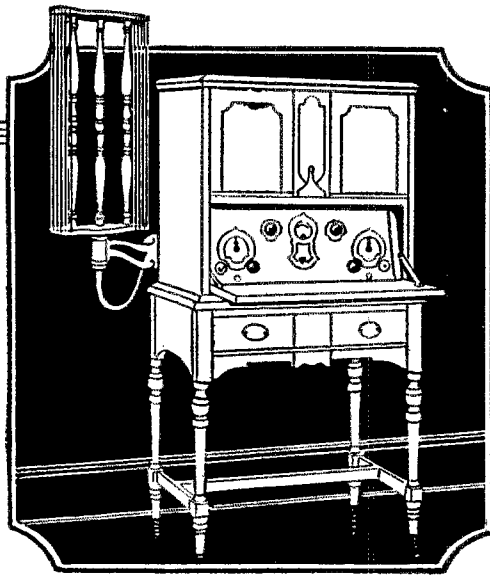

The Totally Shielded Receiver With "Universal" Features

The new Stromberg-Carlson "Universal" 6-tube Receivers appeal to those experienced amateurs who are seeking the utmost in broadcast reception.

Features of the "Universal" models include:

Choice of operating power—either house socket power or batteries.

Choice of apparatus for audio amplification—either internal amplification with UX-112 tubes or UX-171 tubes or external amplification with super-power amplifier.

Choice of pick-up device—either loop or antenna.



Totally Shielded

The total enclosure of each of the three radio stages and the detector stage in separate heavy copper shields, prevents all local pick-up of signals, greatly increases selectivity and distance ability, and produces unexcelled tone quality.

No. 602 Art Console (above) American Walnut; space for all operating equipment. 6-tube totally shielded dual control; equipped with volt-meter. Furnished in both "Universal" and "Regular" models.

Receiver, Universal with external cone speaker (Loop Extra)	Rockies East of	Rockies and West	Canada
	\$365.00	\$385.00	\$510.00
Receiver, Regular (built-in speaker and without the Universal features)	340.00	360.00	470.00
No. 101-A Loop Outfit..	22.50	25.00	31.50

Receiver prices are less accessories



STROMBERG-CARLSON TELEPHONE MFG. CO.
ROCHESTER, NEW YORK

Stromberg-Carlson

THE COMMUNICATIONS DEPARTMENT, A.R.R.L.

ATLANTIC DIVISION

SCM Western N. Y.	8PJ	C. S. Taylor	598 Masten St.	Ruffalo
SCM So. N. J.*	3EH	H. W. Densham	140 Washington St.	Collingswood
SCM West. Pa.	8XE	G. L. Crossley	State College	Pa.
SCM East. Pa.	8RQ	H. M. Wallace	597 No. James St.	Hazleton
SCM Delaware*	3AHS	H. H. Layton	805 Washington St.	Wilmington
SCM D. of C.*	3AB	A. B. Goodall	1824 Ingleside Terrace	Washington

CENTRAL DIVISION

SCM Illinois	9AAW	W. E. Schweltzer	1264 Hazel Ave.	Chicago
SCM Indiana	9CYQ	D. J. Angus	310 N. Illinois St.	Indianapolis
SCM Kentucky*	9ET	J. C. Anderson	Glengarry Farm	Lexington
SCM Michigan	8ZZ	G. E. Darr	137 Hill Ave.	Highland Park, Detroit
SCM Ohio	8BYN	H. C. Storck	694 Carpenter St.	Columbus
SCM Wisconsin	9VD	C. N. Grapo	443 Newton Ave.	Milwaukee

DAKOTA DIVISION

SCM No. Minn.*	9EGU	C. L. Barker	Henning	
SCM S. Minn.	9ZT	D. C. Wallace	54 Penn Ave.	No., Minneapolis
SCM So. Dak.*	9CH	M. J. Jenkins	Bryant	
SCM No. Dak.*	9EFN	G. R. Moir	820 4th St.	Fargo

DELTA DIVISION

SCM Miss.	5AKP	J. W. Gullett	819 29th Ave.	Meridian
SCM Ark.*	5XAB	Dr. L. M. Hunter	207 1/2 Main St.	Little Rock
SCM Tenn.*	1KN	L. K. Rush	3 Second St.	Bemis
SCM La.*	5UK	C. A. Freitag	820 Porshey St.	New Orleans

HUDSON DIVISION

SCM No. J.*	2WR	A. J. Wester, Jr.	1075 Chancellor Ave.	Hilton
SCM N. Y. C. & L. I.*	2CWR	E. H. Marston	1309 W. Farms, Ltd.	Bronx
SCM East. N. Y.*	2PV	H. N. Ammenheuser	178 Quail St.	Albany

MIDWEST DIVISION

SCM Iowa	9DOA	L. R. Huber	Tipton	Iowa
SCM Kansas*	9CWS	G. M. Lewis	312 E. Rutledge St.	Yates Center
SCM Missouri	9RR	L. B. Lazure	8020 Merrier St.	Kansas City
SCM Nebraska	9BYG	C. E. Diehl	3006 S. 32d Ave.	Omaha

NEW ENGLAND DIVISION

SCM Maine	1B1G	Frederick Best	13 E. Crescent St.	Augusta
SCM Conn.	1BM	H. E. Nichols	82 Elmwood Ave.	Bridgport
SCM New Hamp.	1AT1	V. W. Hodge	227 Main St.	Claremont
SCM R. I.*	1BYR	D. B. Fancher	86 Franklin St.	Westerly
SCM Vt.	1AJG	G. T. Kerr	Poultney	
SCM East. Mass.	1BYL	R. S. Briggs	393 Ashmont St.	Dorchester
SCM West. Mass.	1DB	A. H. Carr	30 Vassar St.	Worcester

NORTHWESTERN DIVISION

SCM Mont.*	7NT	A. R. Willson	Ramsay	
SCM Wash.*	7PD	Otto Johnson	4340 30th West	Seattle
SCM Ore.*	7TP	A. C. Dixon, Jr.	1350 East 36th St.	Portland
SCM Idaho*	7OB	K. S. Norquest	Weather Bureau	Boise
SCM Alaska*	7DI	Leo H. Machin	Box 452	Cordova

PACIFIC DIVISION

SCM So. Sect.	6RUR	L. F. Smith	340 No. Painter Ave.	Whittier
SCM Dist. 3 (No. Sec)*	6NX	F. J. Quement	51 Pleasant St.	Sun Jose
SCM Dist. 5 "	6AHG	J. L. Loebner	635 52nd St.	Oakland
SCM Dist. 6 "	6RAF	St. Clair Adams	Eureka	
SCM Nevada "	6TU	C. B. Newcomb	Yarrington	
SCM Hawaii	6TQ	K. A. Cantin	1593 Piikoi St.	Honolulu

ROANOKE DIVISION

SCM N. C.*	1TR	R. S. Morris	413 S. Broad St.	Gastonia
SCM Va.*	3CA	J. F. Wohlford	118 Cambridge Ave.	Roanoke
SCM W. Va.*	8BSU	C. S. Hoffman	126 Chantal Court	Wheeling

SOUTHEASTERN DIVISION

SCM Fla.*	1GY	W. E. Grogan	Box 816	Ft. Myers
SCM Ala.	5AJP	A. D. Trum	217 Catoma St.	Montgomery
SCM Ga.*	South	Carolina--Porto Rico--Isle of Pines	Cuba	
	410*	J. Morris	58 Frederica St.	Atlanta, Ga.
	4RR*	A. Dupre	290 Wolford Campus	Spartanburg, S. C.
	401*	Luis Rexach	Box 319	San Juan, P. R.

ROCKY MOUNTAIN DIVISION

SCM Colo.*	9CAA	C. E. Stedman	1641 Albion St.	Denver
SCM Wyoming-Utah*	7ZO	N. R. Hood	1022 S. Ash St.	Casper, Wyo.
	8ZT	Art Johnson	247 E. 7th South St.	Salt Lake City

WEST GULF DIVISION

SCM No. Tex.*	5AJT	W. B. Forrest	592 Royal St.	Waxahatche
SCM So. Tex.	5YK	F. A. Sahn	Box 569	New Braunfels
SCM Okla.	5APG	K. M. Ehret	2904 N. G. Robinson St.	Oklahoma City
SCM New Mex.				

MARITIME DIVISION

SCM Newfoundland	8AR	Loyal Reid	Avalon House	St. Johns
SCM P. E. Island	1RZ	T. A. Hyndman	Charlottetown	P. E. I.
SCM New Brunswick*	1ET	T. B. Lacey	c/o N. B. Power Co.	St. John, N. B.
SCM Nova Scot.*	1DD	W. C. Borrett	14 Sinclair St.	Dartmouth

ONTARIO DIVISION

SCM Ont.*	9RT	W. Y. Sloan	167 Close Ave.	Toronto
-----------	-----	-------------	----------------	---------

QUEBEC DIVISION

SCM Quebec*	3BE	Alex Reid	202 Birch Ave.	St. Lambert
-------------	-----	-----------	----------------	-------------

VAN-ALTA DIVISION

SCM B. C.*	5G*	Felix E. Bat	211 8th Ave. E.	Prince Rupert, B. C.
SCM Alber. a*	4GT	A. H. Asmussen	223 2nd Ave., N. E.	Calgary, Alta.

PRAIRIE DIVISION

SCM Sask.*	4CR	E. L. Maynard	Morse	Sask.
SCM Man.*	4DH	P. E. Rutland, Jr.	452 St. John Ave.	Winnipeg, Man.

*Temporary officials appointed to act until the membership of the Section concerned choose permanent SCMs by nomination and election.

**Active stations in this Section are requested to report to SCM Layton of Wilmington, Del.

Especially Designed for the Amateur

FOR years Grebe has been closely linked with amateur radio. And now it is the first company to build a receiver especially adapted to amateur needs—the CR-18.

It is a coupled regenerative circuit adapted for reception of frequencies between 1500 and 30,000 Kilocycles (10-200 meters).

Other features are:

An *Antenna Coupling Coil* which provides variable electro-magnetic coupling between antenna and grid circuit. Permits of harmonic tuning to increase signal strength, gives greater selectivity and reduces interference and induction noises.

Losses are reduced to a minimum.

Plug-in Coils allow rapid-change from one frequency to another.

Grebe S-L-F Condensers insure ease

of tuning and maximum signal strength.

Beat Frequency Control permits tuning to a fraction of a kilocycle.

Plate Circuit gives smooth control of regeneration without affecting wavelength calibration and tuning.

Cushion Sockets eliminate microphonic noises.

Six Self-Supporting Air Dielectric Coils are instantly interchangeable.

*Write for detailed description of this,
the last word in low-wave receivers.*

A. H. Grebe & Co., Inc., 109 West 57th Street, New York

Factory: Richmond Hill, N. Y.

Western Branch: 443 So. San Pedro Street, Los Angeles, Cal.

The GREBE CR-18

This company owns and operates stations WAHG and WROQ; also low-wave rebroadcasting stations, Mobile WGMU and Marine WRMU, and stations 2ZV and 2XE.



"If you have fields and will not plow them, your barns will be empty."

If you want the best in radio and do not buy the CR 18, you must blame yourself.

Doctor Wm

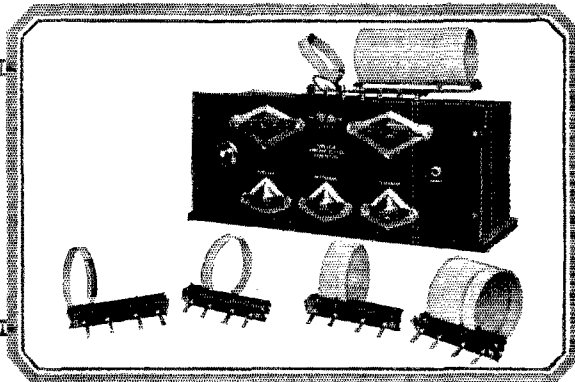

Front view of CR-18 with 200 meter coil intake and additional coils for 10, 20, 40 and 80 meter bands.



All Grebe apparatus is covered by patents granted and pending.

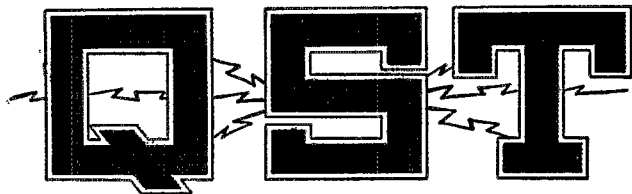

The Official Organ of the A.R.R.L.

VOLUME X

AUGUST 1926

NUMBER 8

Editorials	7
Mercury Arc Rectifiers	<i>A. B. Goodall</i> 8
Fixed Air Condensers	11
Short-Wave Radio in the Antarctic	<i>Lief Jenssen</i> 12
Capacity in Micromicrofarads	<i>Rufus P. Turner</i> 14
A Shielded Wavemeter for Your Station	<i>F. H. Schnell</i> 15
At the Sign of the Diamond	17
Unusual Set Construction	18
A.R.R.L. Information Service Rules	18
Improved Transmitting Circuits	19
New Variable Condensers	21
Tuning Tricks	<i>Paul M. Mueller</i> 22
Operating Receiving Filaments Without Batteries	<i>Robert S. Kruse</i> 25
The "A" Substitute Problem	<i>E. M. Roeder</i> 28
Straightening Out the Antenna	<i>Benjamin S. Melton</i> 30
A 20-40-Meter Crystal Controlled Transmitter	<i>L. B. Root</i> 33
Central New York State (Atlantic Division) Convention	35
A Grid-Meter Driver	<i>W. A. Hoffman</i> 36
Ohio State (Central Division) Convention	37
Another Mystery	<i>Rufus P. Turner</i> 38
Convention Success	<i>Don C. Wallace</i> 39
Experimenters' Section	41
Amateur Radio Stations <i>2AHM 1AXA</i>	43
I.A.R.U. News	46
A Sub-Panel Dial	49
Calls Heard	50
The First Atlantic Division Convention at Buffalo	52
The Communications Department	53
Correspondence	65
HAM-ADS	91
QST's Directory of Advertisers	94

QST is published monthly by The American Radio Relay League, Inc., at Hartford, Conn., U. S. A.
 Official organ of the A.R.R.L. and the International Amateur Radio Union

Kenneth B. Warner (Secretary, A.R.R.L.),
 Editor-in-Chief and Business Manager

F. Cheyney Beekley
 Managing Editor and Advertising Manager

Robert S. Kruse
 Technical Editor

John M. Clayton
 Assistant Technical Editor

David H. Houghton
 Circulation Manager

Subscription rate in United States and Possessions, Canada, and all countries in the American Postal Union, \$2.50 per year, postpaid. Single copies, 25 cents. Foreign countries not in American Postal Union, \$3.00 per year, postpaid. Remittances should be by international postal or express money order or bank draft negotiable in the U. S. and for an equivalent amount in U. S. funds.

Entered as second-class matter May 29, 1919, at the post office at Hartford, Connecticut, under the act of March 3, 1879. Acceptance for mailing at special rate of postage provided for in section 1103, Act of October 3, 1917, authorized September 8, 1922. Additional entry as second-class matter, acceptable at special rate of postage provided for above, at Springfield, Mass., authorized September 17, 1924.

Copyright 1926 by the American Radio Relay League, Inc., Title registered at United States Patent Office.
 Member of the Radio Magazine Publishers' Association.

THE AMERICAN RADIO RELAY LEAGUE

The American Radio Relay League, Inc., is a non-commercial association of radio amateurs, bonded for the promotion of interest in amateur radio communication and experimentation, for the relaying of messages by radio, for the advancement of the radio art and of the public welfare, for the representation of the radio amateur in legislative matters, and for the maintenance of fraternalism and a high standard of conduct.

It is an incorporated association without capital stock, chartered under the laws of Connecticut. Its affairs are governed by a Board of Directors, elected every two years by the general membership. The officers are elected or appointed by the Directors. The League is non-commercial and no one commercially engaged in the manufacture, sale or rental of radio apparatus is eligible to membership on its Board.

"Of, by and for the amateur", it numbers within its ranks practically every worth-while amateur in the world and has a history of glorious achievement as the standard-bearer in amateur affairs.

Inquiries regarding membership are solicited. A bona fide interest in amateur radio is the only essential qualification; ownership of a transmitting station and knowledge of the code are not prerequisite. Correspondence should be addressed to the Secretary.

OFFICERS

President
HIRAM PERCY MAXIM
Hartford, Conn.

Vice-President
CHAS. H. STEWART
St. David's, Pa.

Communications Manager
F. E. HANDY
Hartford, Conn.

Treasurer
A. A. HEBERT
Hartford, Conn.

Secretary
K. B. WARNER
Hartford, Conn.

DIRECTORS

President
HIRAM PERCY MAXIM
Drawer 4,
Hartford, Conn.

Vice-President
CHAS. H. STEWART
St. David's Pa.

Canadian General Manager
A. H. K. RUSSELL
6 Mail Bldg.,
Toronto, Ont.

Atlantic Division
DR. EUGENE C. WOODRUFF
284 W. Fairmount Ave.,
State College, Pa.

Central Division
CLYDE E. DARR
187 Hill Ave., Highland Park,
Detroit, Mich.

Dakota Division
C. M. JANSKY, JR.
Dept. of Elec. Eng., U. of M.,
Minneapolis, Minn.

Delta Division
BENJ. F. PAINTER
424 Hamilton Nat'l Bank Bldg.,
Chattanooga, Tenn.

Hudson Division
DR. LAWRENCE J. DUNN
480 East 19th St.,
Brooklyn, N. Y.

Midwest Division
PORTER H. QUINBY
Box 134A, Route 6,
Omaha, Neb.

New England Division
DR. ELLIOTT A. WHITE
Dartmouth College
Hanover, N. H.

Northwestern Division
K. W. WEINGARTEN
3219 No. 24th St.,
Tacoma, Wash.

Pacific Division
ALLEN H. BABCOCK
65 Market St.,
San Francisco

Roanoke Division
W. TREDWAY GRAVELY
508 Main St.,
Danville, Va.

Rocky Mountain Division
PAUL M. SEGAL
c/o District Attorney,
West Side Court Bldg.,
Denver, Colo.

Southeastern Division
HARRY F. DOBBS
c/o Dobbs & Wey Co.,
Atlanta, Ga.

West Gulf Division
FRANK M. CORLETT
2515 Catherine St.,
Dallas, Tex.

Address General Correspondence to Executive Headquarters, Hartford, Conn

EDITORIALS

Part of the Game

THE first of *Popular Radio's* Medals for Conspicuous Service have been awarded to the operators of c4AG and u9EBT for meritorious service in the saving of human life when, back in late 1923, they succeeded thru their amateur stations in getting a doctor and medical assistance to an expectant mother at a lonely outpost in the Canadian wilderness. In a gripping two-page story in July *Popular Radio*, J. Andrew White graphically relates the story of devotion to duty in the face of terrific obstacles which finally resulted in saving the lives of the mother and her child.

In *QST* for January of 1924 we reported this service, giving the story a total of just twenty-two lines! We reported it baldly and in quite a matter-of-fact way. We have been wondering the last few days why it was that this occurrence, which originated within our own membership, appeared to be written up by us so completely without inspiration, and how it was that nearly three years later it makes a really thrilling tale in a more popular magazine. We wondered for a while if it could be our own lack of discernment, even tho we think we have some writers on our staff who are able to write lucidly and enthusiastically. But no, that isn't it. The answer is that such accomplishments are all part of the day's work in amateur radio and our A. R. R. L. history is so replete with them that this particular service, magnificent as it was, was just one more accomplishment to the credit of organized amateur radio. Why, just the other day we unearthed the tale of the quiet work of an Illinois amateur who was of inestimable assistance at the time of the Southern Illinois tornado a couple of years ago. He hadn't said a word about it, he hadn't even sent us a copy of his log; when we asked him about it he laconically described what he had done and didn't seem to think much of it. All of us know dozens of such instances. As amateurs go quietly about their communication, occasionally there comes an opportunity to be of service in a crisis. Perhaps it concerns the life of one person, possibly the security of a whole community. It is all the same; it is a chance to put amateur skill to the test, and if the obstacles are huge, so much the greater the satisfaction of doing the job well. And, after all, isn't that the greatest reward an amateur could possess—the satisfaction of a hard job well done? Of such

stuff is amateur radio made, and we have a right to be proud of it, even tho, when a deed is done which thrills the public to the eyebrows, it is "just one more accomplishment" with us amateurs.

The Libraries

DOES *QST* come to the reading table in your home-town public library? If it doesn't, will you spare us a few minutes some day soon and drop around and tell the librarian about *QST* and see if you can get the subscription?

Quite a few public libraries already get *QST* but they are only a small percentage of the whole. In many cases local amateurs were responsible for the first subscription; the renewals come in automatically, for the readers at every library find *QST* interesting. We remember that 2ADH "sold us" to the Yonkers Public Library, that 8CPY did the same at Kalamazoo, and there have been dozens of such cases. Letters to librarians have little effect in this direction; if we could have a few minutes in person with each of them we could do the trick, but of course we can't do that either. But if our members themselves can spend a few moments for us, it can be done just as surely.

Now that the experimentally-inclined portion of the radio public is heading towards short-wave transmission, we know that they need *QST* and that it will be well received. And this says nothing about the assistance your help will be to the League and in strengthening the position of amateur radio generally. Many thanks, fellows.

To Newsstand Readers

EVER have that hopeless feeling when your newsstand is out of *QST*? Ever find it impossible to get the current issue and have to wait long days while you ordered a copy from Hartford? Of course you did, for economy of distribution demands that no great surplus of copies be put on the stands and some of them are sure to run short. How jolly it would be to have the postman bring you *QST* right to your door each month, to be sure of getting it, and to have it early! And to be a *member* of the League at the same time!

It is for just such folks as you that we print that convenient little blank on page 86. It will do the business. How's to use it?

K. B. W.

Mercury Arc Rectifiers

By A. B. Goodall*

Some time ago QST began collecting information about the use of Mercury Arcs for transmitting plate supply. At first the information was all contradictory, but in the last year some reliable arrangements have been developed, particularly at Washington, D. C., where a considerable group of the devices is in successful operation.—Tech. Ed.

THE mercury arc rectifier may be termed a gas tube because its operation depends upon mercury vapor. When the tube is cold, the vacuum is quite high. The life of a mercury arc rectifier tube depends on the maintenance of its vacuum. The arc takes place in the mercury vapor between an upper cold

some point in the mercury pool at a high temperature. This can be done by the load on the rectifier but if the load is taken off the arc will go out. However, the rectifier must work on intermittent load to be of any use to the telegraphing amateur and the object of this article is to decide on a method by which it may be so used. This method is mainly a means for keeping a "hot spot" on the mercury pool.

At all but one of the stations here a small 220-volt 110-amp. tube is being used and has been found very satisfactory. In the photographs and circuit diagrams an auxiliary pool will be seen. The function of this is ordinarily to act as a starting electrode to form an initial flash on the main pool. In the present case this auxiliary electrode is operated constantly to maintain the hot spot. This is accomplished by supplying a direct current to the auxiliary and main mercury pools to maintain a miniature arc between them as shown in Fig 1. The transformer 1 has a 110-volt primary and a secondary giving 50 volts on both sides of the center tap. The output of the transformer is connected to the electrolytic rectifier 2 employing a couple of very large jars. Half-gallon battery jars are good. The choke 3 is necessary to prevent the keep-alive arc from going out between half cycles. The keep-alive arc is started by tilting the tube. The normal current in this circuit is $1\frac{1}{2}$ to $2\frac{1}{4}$ amperes and the voltage across the electrodes is approximately $14\frac{1}{2}$ volts. The size of the choke 3 is important. The inductance value in general is not critical but must be within certain limits. It is suggested that if convenient to wind one, a closed core anywhere from one inch cross section up be selected and several hundred turns of No. 18 wire be wound with taps brought out at intervals. A satisfactory choke being used at several stations in Washington has the following dimensions: Core of Silicon steel $1\frac{3}{4} \times 1\frac{3}{4}$ inches with windings $1\frac{3}{4} \times 4$, making outside dimensions $5\frac{1}{4} \times 7\frac{1}{2}$ inches. One leg of the core is wound with 180 turns of No. 17 wire. Transformer 1 may be of about 200 watts capacity the main features in its construction being that the secondary and primary must be well insulated from each other since as seen from Fig. 2 the secondary-to-

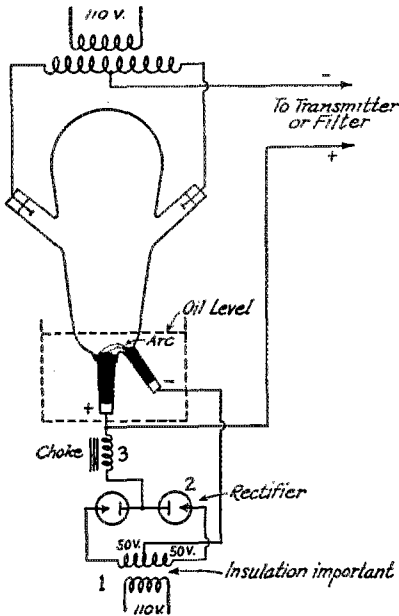

FIG. 1. SIMPLEST FORM OF THE ELECTROLYTIC "KEEP-ALIVE" SYSTEM

electrode (anode) and a lower electrode (cathode) which consists of a mercury pool which is incandescent at the spot where the arc strikes. This conducts electricity but when the current is reversed no conduction takes place with this particular pair of electrodes. The rectifying action depends, amongst other things, on keeping

* A. B. Goodall, 3AB, 1824 Indleside Terrace, Washington, D. C.

ground insulation must withstand the full plate supply voltage and any surges which of course may develop. The secondary should have a center tap and should develop about 50 volts on each side.

Obviously other forms of rectifier 2 may be employed such as four cells arranged in bridge in which case the secondary voltage of the transformer 1 need be only one-half that needed for the center tap rectifier, that is, about 50 volts. At one station in Washington two large Tungar tubes are used in place of the electrolytic rectifier cells 2, and at another station small Tungars are used, all proving satisfactory.

It may be necessary to add a little resistance some place in the "keep-alive" circuit to limit the current. It would appear that the proper value of resistance in this circuit would be a value a little over sufficient to maintain the arc from going out. Resistance in the circuit also acts to stabilize the arc. The electrolytic rectifier generally has sufficient inherent resistance to do this.

If the keep-alive arc does not start upon tipping the tube, or where the arc is continually going out, it is probable that the choke is not of correct value, or the electrolytic rectifier is not "formed" or has too high a resistance. If the mercury arc tube is defective due to poor vacuum it will not operate. Poor vacuum may be tested by shaking the tube and noting the sound caused by the splashing mercury. A vacuum will give a peculiar clicking sound. An oxide scum will form on the surface of the mercury in attempting to start the arc if there is air in the tube.

In mounting the tube care should be taken that no strain is imparted upon the glass arms by any clamps used. We had one casualty because of this and it is the only casualty we have had to date. A peculiar property of glass is that it may fracture if a continued stress is applied to it though the fracture may take several days in developing. Fig. 1 shows another important item, namely, the oil bath. In the operation of the tube, the portion of the glass immediately adjacent to the "keep-alive" arc has a tendency to get very hot, due to radiation of heat from the arc flame above it. The jar indicated by dotted lines in Fig. 1 should house the tube up to a level above the surface of the mercury pool. The jar should be filled with a light oil such as Mobile E or an engine "flushing" oil.

The connection of the rectifier tube to the transmitter is done in the same manner as

with any other rectifier and the same keying methods may be used. The output may be filtered, or not as desired. The arc incidentally takes filtering very nicely.

Fig. 2 shows a modification which has been worked out and used for nearly a year at my station. The system allows remote control of the rectifier and so does not require tipping of the tube manually. The rectifier tube is mounted in a wooden frame

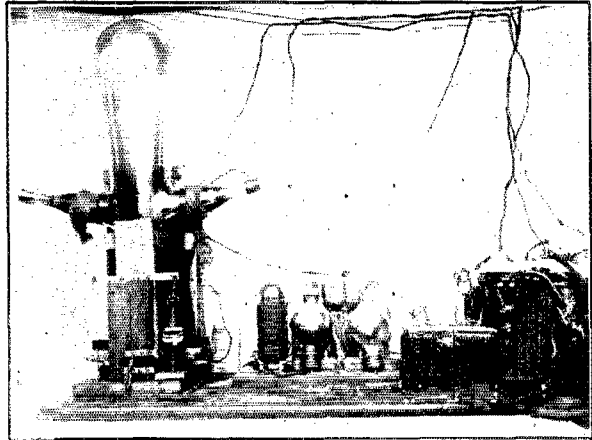

TUNGAR "KEEP-ALIVE" ARRANGEMENT AT 3AB, USING CIRCUIT OF FIG. 2

with the oil jar, neither of which are shown in Fig. 2. The tube with its frame is then pivoted on a line thru the center of gravity (point A in Fig. 4), in a second larger wooden support. A rod B is secured to the tube frame as shown, a coil spring

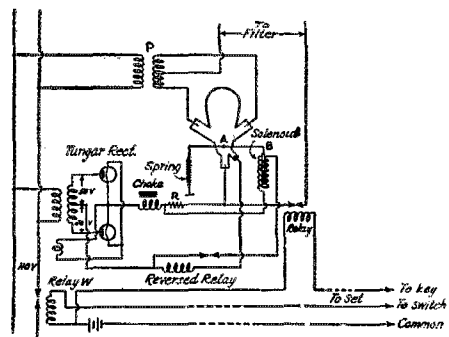

FIG. 2. THE COMPLETE CIRCUIT AT 3AB, INCLUDING REMOTE CONTROL SYSTEM

connected on one end and a solenoid armature connected on the other and so mounted that the solenoid when energized will tilt the tube. Both the solenoid and the "keep-alive" arc are excited by the Tungar rectifier. In the "keep-alive" circuit is placed a relay, the contacts of which are closed when

the relay is de-energized. The operation is as follows: When the 110-volt supply is closed through the relay W, both the power transformer P and the Tungar rectifier are energized. The circuit through the solenoid being closed, the latter is actuated to tip the tube. This short circuits the "keep-alive" arc and allows current to pass through this latter circuit. The re-

operation has been quite reliable, having arc rectifier over other rectifiers for high voltage plate supply rectification as evidenced from over a year's continued use of this type of rectifier are as follows:

Efficiency: The drop in potential in the tube is only about 14½ volts. The power efficiency, of course, varies with the power consumed by the "keep-alive" circuit and the load on the tube. The service efficiency is equal to kenotrons; it is always on the job.

Life: The life of the mercury arc tube as used by the above described method is unknown. The tube used at 3AB was in its second childhood when first set up over a year ago and shows no signs of departing this life. The tube at 3BWT has been conservatively estimated as having "done its stuff" for 1300 hours.

Output: The tone of a transmitter using a mercury arc is similar to one using a good electrolytic rectifier.

Cost: In the long run the mercury arc rectifier is probably the cheapest of all rectifiers for amateur use.

Capacity: Voltages of over six thousand have been used here and there is no reason why this value may not be greatly exceeded.

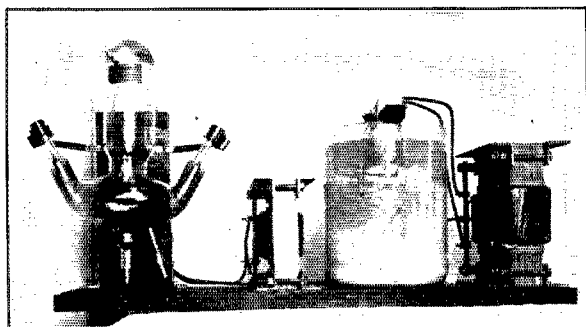

ELECTROLYTIC "KEEP-ALIVE" ARRANGEMENT AT 3CDQ. THE STATION OF MISS E. M. ZANDONINI AT WASHINGTON, D. C.

versed relay is hence energized, breaks the solenoid circuit and allows the tube to right itself through the action of the spring.

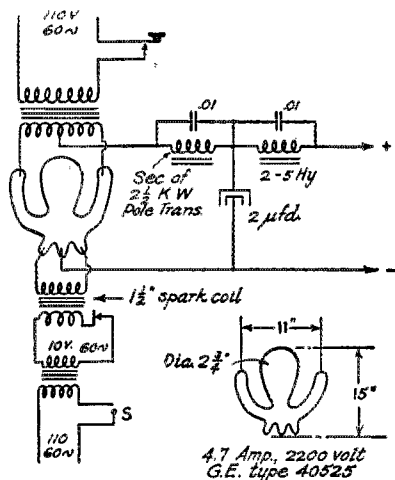

FIG. 3. "KEEP-ALIVE" CIRCUIT USED BY R. E. LATHROP, WAUKESHA, WIS.

The small sketch shows the type of lamp used. This lamp could also be used in the circuit of Fig. 4. The spark coil idea, however, fits any type of tube though the vibrator may give trouble on long runs.

Upon the tube returning to normal position, the arc is formed. This arrangement is really simpler than it looks and the given no trouble during the year it has been in use.

The advantages possessed by the mercury

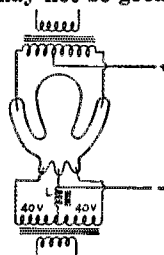

FIG. 4. CIRCUIT TO BE USED WITH LAMPS HAVING THREE MERCURY ELECTRODES SUCH AS GENERAL ELECTRIC TYPE 40525

Interference: By interference is meant QRM to nearby receivers. This is a very important factor and one which should condemn an otherwise efficient rectifier. The "keep-alive" arc causes no interference and break-in transmission may be employed very conveniently.

Much credit must be given to the fellows about town who are using the mercury arc for their invaluable aid in supplying the necessary performance data on which this article is based and particularly to Donald Basim of 3CKG who has assisted in popularizing the arc by constructing a number of complete rectifier sets.

Miscellaneous Hints

John L. Peters of East Holliston, Mass.,

gives a great deal of interesting information which cannot be reproduced in full here. He suggests the use of a tube having two auxiliary electrodes like the one shown in

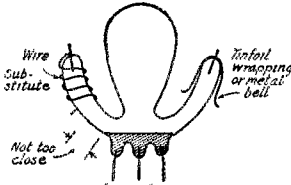
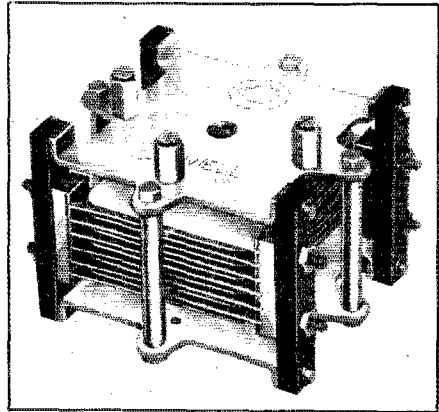

FIG. 5. STATIC SHIELD USED AT 7EC, 1XM, AND ALSO 1CQK TO STEADY OLD LAMPS

Fig. 3, but instead of the spark coil recommends the arrangement of Fig. 4, which has also been in use for some time by Oney Johnson at 7EC which is in Astoria Oregon. Both of these men suggest that suitable tubes are those which have begun to operate unsteadily in a series lighting system. These tubes can be obtained for little or nothing from the lighting companies. What ails the tubes is not entirely clear but it has something to do with a deposit of mercury on the inside of the glass arms. A considerable improvement may be made, according to Mr. Peters, by hanging the tube rightside up in water and boiling it for 15 or 20 minutes. The vacuum can be tested as suggested by Goodall being very careful not to shake the mercury right thru the glass. Mr. Johnson says that tubes which have become useless in lighting service will still serve for years as amateur plate rectifiers. Using the arrangement of Fig. 4 he says that it depends upon the individual tube just what voltage will be necessary but that something between 30 and 55 will be right. The choke L must be somewhere near right but is not critical. 1000 turns of No. 20 wire on a closed core 1 1/4" square (cross-section) will do although there has been used at 7EC the primary of a Radio Corporation UP1656 75-watt filament transformer, also the primary of another transformer having 270 turns on a close core of 1 5/8" cross section. The tube carrier used at 7EC is shown in Fig. 5. From the other remarks in 7EC's letter it seems that this is a General Electric tube catalog 40525. This tube by the way has a rating of 20-KW.

Just one more thing from 7EC's letter: "The tubes are shipped upsidedown with all the mercury run into the large condensing chamber. When you pour it back do it slowly or you may crack one of the arms."

the one shown in the photograph are now available. The condensers are made by Cardwell, and employ the standard Cardwell construction, so well known in their variable receiving line. These condensers are valuable as plate and grid condensers, antenna series condensers and either antenna or primary loading condensers (being shunted across existing variables not having the required maximum capacity). Three types of condenser are to be had. They are; twelve plate with a 250μfd. capacity, twenty plate with a 400-μfd. capacity and forty-two plate with a 966-μfd. capacity. All of these have a high frequency breakdown voltage of 3,000. In addition a much larger



condenser having twenty two plates, a capacity of 250-μfd. and a breakdown voltage of 5,250 is stocked. This condenser is for use with sets using over 500 watts. Being of the air dielectric type the condensers are self-healing, a flash-over doing no particular harm to the condenser. Both sets of plates are insulated from the end frame and tie bolts, allowing the cases to be grounded or used in shielded transmitters where the condensers would otherwise have to be insulated.

—J. M. C.

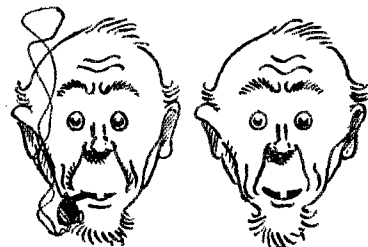

TWO MIKES. 88MM
TO CONFORM WITH 8UX6 1/2 HENRYS

Fixed Air Condensers

FOR use with short-wave c. w. sets employing powers up to and including an overloaded quarter K. W. tube, fixed condensers of the dielectric type similar to

Short-Wave Radio in the Antarctic

By Lief Jenssen*

With no blare of trumpets and with no advance preparations as far as the general public was concerned, the Ross Sea Whaling Expedition set out in 1925 to fish in the most southerly open waters of the Antarctic. Very shortly after arriving in the south the amateur radio world became acquainted with AQE, the call of the short wave radio set on the main ship of the expedition. With comparatively low power on short waves AQE was able to maintain nightly contact with the rest of the world, whereas, before when the longer waves had been relied upon, the Expedition was cut-off from the rest of the world a large part of the time.—Asst. Tech. Ed.

WHEN the Ross Sea Whaling Expedition was under preparation in 1923, in the little town of Sandefjord, Norway, a question, which was by no means the least important, was that of establishing a reliable wireless contact with some station on shore during the time the fleet was laying in the Antarctic. Bearing in mind the extraordinary condi-

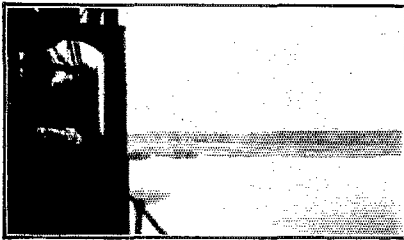

ONE OF THE SEVEN WONDERS OF THE WORLD
The ice barrier is upwards to 150 feet high and hundreds of miles long, and all solid ice.

tions that this expedition would have to reckon with, the lives of some two hundred men to be responsible for, the risk of damage to the ships in ice, etc., it was obvious that only the best wireless gear could be used. It was then decided to install a 3-K.W., C. W. and telephone transmitter of the type just turned out by the Marconi Works in England. In addition to this the equipment comprised a 1½-K. W. spark* set and a 7-tube HF amplifier and detector combined, and a two stage audio frequency amplifier. The rather high powered receiving equipment was thought necessary in view of the great amount of daylight communication which would be carried on over comparatively great distances.

I found the Awarua radio station (VLB) situated at the southern point of the south island of New Zealand to be the best station to work from the Ross Sea, and at my request the officer in charge of that station, Mr. L. Steel, promised to assist us. After some tests on telephony with him, we decided to exchange telegraph signals twice daily, both stations using a wavelength of 2,000 meters. The transmitter at VLB consisted

of a 35-K.W. Telefunken spark set. All went well. The *Ross* was creeping southward all the time and VLB reported signals as "Qsa vy, do not seem to get weaker."

Soon after Christmas of 1923 we arrived at Discovery Inlet at the great Ice Barrier and anchored there. From that moment on all our "Qrk Qsa" business was finished and VLB had a very hard job to pick up AQE's signals for a long time. The Discovery Inlet, named after Sir Ernest Shackleton's ship *Discovery* which found the inlet years ago, is a cut-in of the huge ice barrier. This barrier varies in height from 60 to 150 feet, and is hundreds of miles long. It is all solid ice. The barrier seems to offer a resistance to the passage of wireless waves. The effect is far more pronounced for transmission than for reception, however. As an example VLB was always copied with fine signal strength whereas AQE, with more than 15 amperes in the antenna, was almost continually reported as very QRZ. It is also noticeable that from about the middle of February when twilight was prevailing for a short time, most of the coastal stations

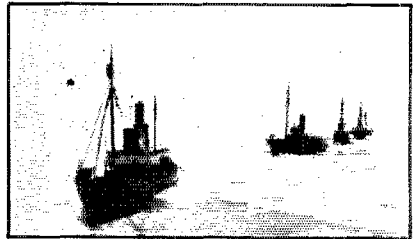

AQE IN THE FOREGROUND WITH THE FIVE WHALE CHASERS BRINGING UP THE REAR
The AQE is a 12,500-ton steel boat.

in Australia, the Hawaiian Islands and all Pacific Coast islands as well as many ships, were coming in quite strong. On March 7th, 1923 we weighed anchor and steamed Northward. Just outside the Inlet signals were exchanged with VLB and from then on it was possible to work him regularly.

Then came the 1924 Expedition. This Expedition gave the same poor radio operation, and badly hampered our communication facilities. Communication with VLB was extremely erratic and AQE's signals were

* Chief Radio Operator, AQE.

always QRZ as soon as we arrived at the inlet.

When plans for the 1925 expedition were being laid Mr. Steel of VLB suggested that we install a short wave transmitter and receiver. When we left Norway on our third trip we had a box full of coils, condensers and other S. W. parts, and an envelope full of diagrams of all types. We were to fix up the short wave set the best we could as no time was left to do the work before sailing. Thanks to Mr. Edwards, z3AO and Mr. Wilde and the staff at VLB we had quite a good transmitter for short wave operation before leaving New Zealand for the south.

Arrangements were made with VLB to

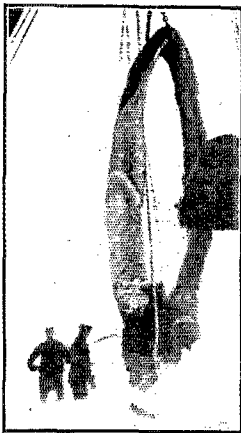

WHAT THEY WERE AFTER. THE LOWER JAW OF A BLUE WHALE
Note the size of the men alongside.

test with him daily on the short wave set. It did not take long to substantiate the claim that the long waves were played out and of little use when compared to 40-meter operation. The results were no less than marvellous to me. On the 2,000-meter wave, with much higher power, it was reckoned as something of a feat to get in touch with San Francisco KFS from 73 degrees South. The short wave transmitter with a 25-foot vertical pipe antenna and a very small fraction of the long wave transmitter's antenna current, would break through not only to San Francisco but to practically any place in the world. With our limited short wave experience, stations as far away as Vancouver, B. C. and Massachusetts were worked from a point about 700 miles north of the South Pole.

When the fleet entered the ice pack in about 65 degrees south latitude, and was tied up alongside the ice for nearly six weeks, we had a good chance to try out the short waves. All communication was carried out in the brightest daylight and no trouble

was had in working amateurs in all parts of the globe. The southernmost point to which the Expedition penetrated was at 78.28 south and 17.10 west, or about 700 miles from the



A VERY FEW OF THE BLUE WHALES CAUGHT
They average 90 feet long. The record length is 105 feet.

Pole. At this position amateur signals from all parts continued to "pour in" in large numbers and a number of stations were worked regularly with little or no trouble. The ice barrier had no effect upon the short waves!

An interesting feature has been noted in the seemingly non-conductivity of ether waves of the polar region from Discovery Inlet across to the South Shetland Islands, on the Graham land across from the Ross Sea. During three successive seasons attempts have been made to reach the whaling fleet laying there, but contact has never been established. Also the English Government's station at Falkland Islands was tried regularly every month with no success. The station there (VPC) is a 10-K.W. C.W. affair operating on a wavelength of 3,000 meters. The distance from the Antarctic to Falkland Island and South Shetland is less than to VLB.

In addition to the 12,500-ton ship *Sir James Clark Ross* the Expedition had five small whale chasers. They are all equipped with direction finders of the Marconi-Bellini-Tosi system. The direction finders are the only aide to the whale chasers in locating the *Ross* in foggy weather, or after the chasers have been out after whales out of sight. When not lying in Discovery Inlet the fleet is "fishing" off the coast of South Victoria Land and is adrift all the time. As the magnetic south pole is close by, the ordinary compass is quite useless, sometimes giving a deviation of as much as 150 degrees. Here the wireless compass steps in, and it is wonderful to see the small boats coming out of the fog steering right for the *Ross*. Spark signals sent out for five minutes during each hour enable the small boats to take bearings on the position of the mothership. The gunners on the chasers have often stated that the wireless compass actually increases their profit by saving time and

coal. They are just as careful with the wireless apparatus as they are with the gun or any other important part of their equipment.

As a curiosity it might be mentioned that last year a few experiments were carried out with a single tube regenerative receiver in which a 201-A tube was used. A microphone was placed in the ground circuit

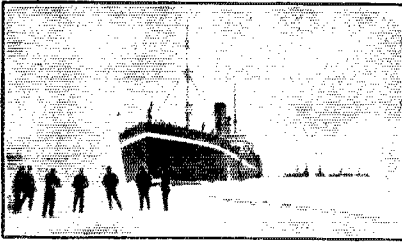

THE FIVE "CHICKENS" BEING TOWED BY THE AQE, THE MOTHER SHIP

Note direction-finding antennas. The AQE sends out spark signals every hour for the chasers to get bearings on, the magnetic compass being useless this far South.

and excellent telephone signals were pushed out over a distance of 50 miles! Two small sets similar to this were put on two of the chasers and gave fine service throughout the past season. All five chasers will probably be fitted with low-power telephone transmitters for the next trip, hence a very busy time is anticipated in the antarctic during the 1926 season.

I am trying to arrange for a regular short wave schedule with Norway from the Ross Sea next trip.¹ This will necessarily include both 20- and 40-meter transmission. It is hoped that amateurs both in Norway and in all other countries of the globe will participate and will be QSO AQE often.

The transmitter on short waves last season consisted of two 50-watt tubes working from a 300-cycle supply with kenotron rectifiers. The antenna was a 25-foot copper pipe set up on the deck of the ship and surrounded by all manner of stays, guys, halyards and other absorbing devices. A direct ground to the steel frame of the ship was taken off about five feet from the transmitter. The receiver was of the usual low loss type using a detector and two stages of audio amplification.

I want to take this opportunity to thank all of the amateurs we worked last trip, and to send regards to those of you who I got in touch with via radio or met personally. CUL es 73, OM.

Capacity in Micromicrofarads

By Rufus P. Turner*

IN ONE of my recent articles, something was said about a five-hundred micro-microfarad variable condenser and as a result I received almost one hundred letters in which the question was asked; "What is a 500- $\mu\mu\text{fd.}$ condenser and what is a micro-microfarad?" Answering the query was not a task but the bill for postage cut deeply into the existing treasury of 3LF and I have taken the time to write this hoping that others who intend to ask me the same question and who do not intend to send stamps or self-addressed envelopes will gather from it the information desired.

First of all, the microfarad is equal to one million micromicrofarads, or (.000001 $\mu\text{fd.}$ equals 1 $\mu\mu\text{fd.}$). Hence if we want to change microfarads to micromicrofarads it is only necessary to add enough ciphers to the right of the figure to make six decimal places altogether and then strike out all ciphers on the right of the figure. For example, we would like to change the capacity, .0005 $\mu\text{fd.}$ into micromicrofarads adding enough ciphers to the right to give six decimal places will give us .000500 and now we strike out all ciphers on the left and we have as a result, 500. So .0005 $\mu\text{fd.}$ is equal to 500 $\mu\mu\text{fd.}$

Here they are in the form of a table.

Micromicrofarads	Microfarads	Micromicrofarads	Microfarads
5	.000005	3,500	.0035
10	.00001	4,000	.004
15	.000015	4,500	.0045
20	.00002	5,000	.005
25	.000025	5,500	.0055
30	.00003	6,000	.006
35	.000035	6,500	.0065
40	.00004	7,000	.007
45	.000045	7,500	.0075
50	.00005	8,000	.008
55	.000055	8,500	.0085
60	.00006	9,000	.009
65	.000065		
70	.00007	10,000	.01
75	.000075	15,000	.015
80	.00008	20,000	.02
85	.000085	25,000	.025
90	.00009	30,000	.03
		35,000	.035
100	.0001	40,000	.04
150	.00015	45,000	.045
200	.0002	50,000	.05
250	.00025	55,000	.055
300	.0003	60,000	.06
350	.00035	65,000	.065
400	.0004	70,000	.07
450	.00045	75,000	.075
500	.0005	80,000	.08
550	.00055	85,000	.085
600	.0006	90,000	.09
650	.00065	95,000	.095
700	.0007		
750	.00075	100,000	.1
800	.0008	200,000	.2
850	.00085	300,000	.3
900	.0009	400,000	.4
950	.00095	500,000	.5
		600,000	.6
		700,000	.7
1,000	.001	800,000	.8
1,500	.0015	900,000	.9
2,000	.002	1,000,000	1.0
2,500	.0025		
3,000	.003		

1—We have just been informed that arrangements have been completed for direct communication between the ship and Norway.—Asst. Tech. Ed.

*8LF, 3AJF, 427 Franklin St. N.W.; Washington, D. C.

A Shielded Wavemeter for Your Station

By F. H. Schnell*

QRH? What is the wavelength of your transmitter? If you don't know, you ought to be ashamed to admit it, yet one deserves more respect for admitting the truth than trying to evade it. You ought to know the wavelength of your transmitter and you ought to know it within a small fraction of a meter on the various amateur bands. If you won't know, there is but one answer—you haven't taken enough interest to find out. Guessing at your wavelength is not good enough. It should be

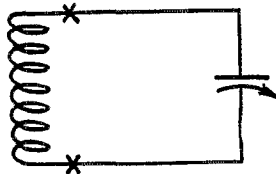

FIG. 1

THE CIRCUIT DIAGRAM

Not one needless thing has been added, nor anything that will change and spoil the calibration.

measured by some reliable receiving operator or, better still, you should have a decently accurate wavemeter in your own station so you can check your wavelength from time to time. Every good amateur station has a wavemeter. The next thing is to use it and use it right.

If this poor little old magazine, *QST*, were burdened in one issue with all the articles that have appeared on wavemeters, there wouldn't be room in the regular number of pages to hold them all. There has been no end of excellent articles dealing with all sorts of wavemeters and I hesitate to think what is running through the minds of "KB", "LQ" and "Beek" as they look this over. Even the printer up in Springfield may refuse to set this up because he just ran off something about wavemeters not more than a couple of days ago. And, surprising as it may seem, these wavemeters are no different from any others that have appeared—they use the same old standard circuit as was used in wavemeters when "KB" was operating his old spark at Cairo,

Illinois and when "LQ" was pulling more than a kilowatt out of his old "Thor" one kilowatt transformer back in Lawrence, Kansas. For fear some of you haven't seen this circuit during the past few days and if I can get it past Kruse, here it is: Fig. 1. If no Fig. 1. appears you will know Kruse put the skids under it.

While I did say these wavemeters were no different from the others, I may have to back-water a bit. These are completely shielded in aluminum cases, otherwise they are the same. Having made enough excuse for writing this, I'd better get to the detailed description of them before I get thrown on my ear.

Two wavemeters were made, one using a 5-plate Karas (.0000972 μ f.) Orthometric condenser and calibrated in meters; the other using a Cardwell tapered plate (.000150 μ f.) type 167-E condenser and calibrated in kilocycles. Each condenser is shielded by an aluminum case, the rotary plates and frames of the condensers being grounded to the top of the case. The aluminum is 0.051" in thickness and is very easy to cut and assemble. Brass angle strip is used to support the top, bottom and sides, 6-32 screws $\frac{1}{4}$ " long being used throughout. The lead from the fixed plates comes

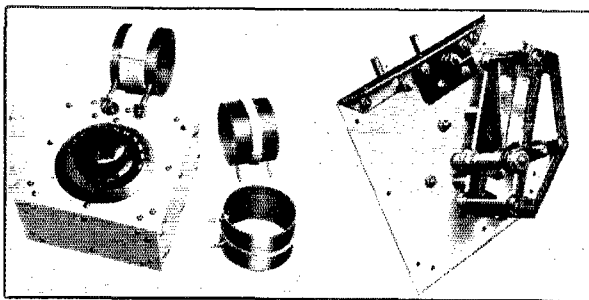

FIG. 2. THE KARAS METER INSIDE AND OUT

through an insulating support of $\frac{1}{4}$ " hard sheet rubber, a hole of $\frac{3}{4}$ " in diameter in the top of the aluminum case provides plenty of clearance. Jacks are spaced $1\frac{1}{2}$ " to take the coils. A National Velvet Vernier 4" dial is used on each wavemeter.

The mounting of the Karas condenser is shown in Fig. 2, the Cardwell in Fig. 3. The Karas condenser case is $5\frac{3}{4}$ " x $5\frac{3}{4}$ " x 3" and the Cardwell case is $4\frac{1}{2}$ " x $5\frac{1}{2}$ " x 3".

Formica tubing 3" in diameter (1/16" wall) is used for supporting the windings. Each coil is wound with No. 16 D. C. C.

*9XH-9EK, C. F. Burgess Laboratories, Madison, Wisconsin; ex-Traffic Manager A.R.R.L.

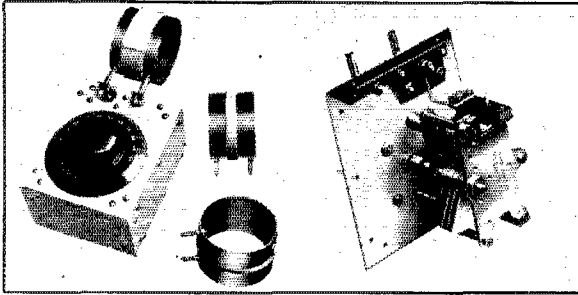

FIG. 3. THE CARDWELL METER INSIDE AND OUT

copper wire. The Formica tubing is cut into lengths of 2" and each coil is fitted with two General Radio type 274-P Plugs, spaced 1½", Fig. 4. Each coil is given two coats of moderately thin shellac. Wait a minute, wait a minute before you get all excited about the use of shellac. Remember, a wave meter is not a low-loss high efficiency receiver. The coils must be fixed permanently if the calibration is to remain nearly accurate. Before the coils are shellaced they are tied in four places with linen twine which acts as a means for preventing the windings from slipping.

Coil winding data for the Karas condenser is as follows:

Coil No.	No. of turns	Wavelength range in meters
B-1	3	10 to 24
B-2	7	21 to 49
B-3	17	40 to 100

The following is for the Cardwell condenser.

Coil No.	No. of turns	Frequency range in kilocycles
A-1	3	10,500 to 28,300
A-2	7	5,000 to 15,000
A-3	16	2,500 to 7,500

The curves show just about what you may expect if you follow dimensions as given. Of course, it is quite obvious that no two coils will be exactly alike in every respect, but they will be near enough so you can count on similar ranges when you are ready to calibrate your wavemeter. It is of interest to note that the amateur bands fall at approximately the same condenser dial settings for each coil. If fractional turns were used, this dial reading could have been made identical for each coil.

If you do make one or the other of these meters, do not rely on the

curves shown for this particular meter and for Heaven's sake don't make the mistake of trying to correct the standard transmissions of the Bureau of Standards or those of 1XM. You may be wrong, therefore check from them. They are right! QST shows the date, hour and frequency or wavelength of transmissions by the Bureau of Standards and 1XM. With your receiver you can pick up these standard transmissions and by setting on zero beat you can calibrate your wavemeter within less than ½ to 1%—it requires care to do it. For extreme accuracy, using this method, the wavemeter should stop

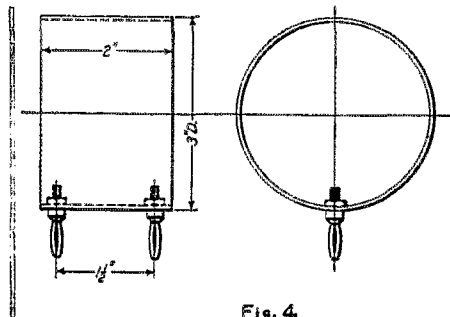
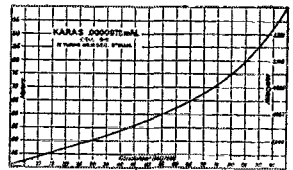
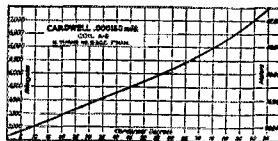
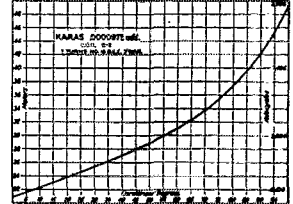
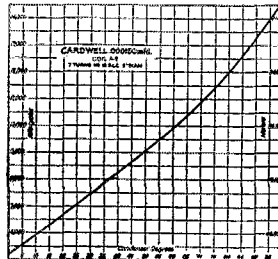
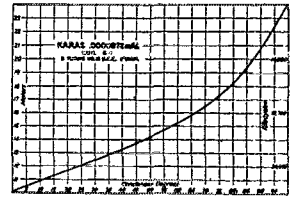
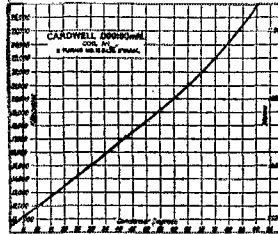

Fig. 4

oscillation in the receiver with a change in the dial setting that is no greater than the width of the line that indicates the degree on the dial.

For use in checking your transmitter, a small flashlight lamp may be used with just one turn of wire (No. 16 for mechanical strength) Fig. 5, about three inches in diameter. When the wavemeter in is resonance with the transmitter the lamp will light. It should be held about two inches from the wave meter coil. Another way is to watch the milliammeter in the plate cir-

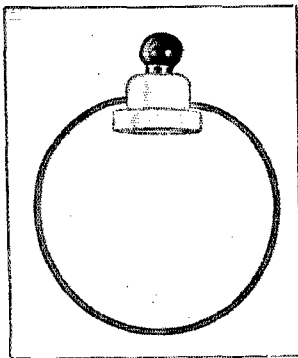

FIG. 5. THE PICKUP LAMP USED WITH A TRANSMITTER

Having the lamp independent avoids changes in calibration, also it reduces the resistance of the meter when it is being used with an oscillator or receiving set. With a lamp right in the meter it is hard to get decent resonance clicks or meter jumps.

cuit of the transmitter. When resonance is obtained, the milliammeter will show a slight increase in plate current. The antenna ammeter is still another good indicator—when resonance is obtained the antenna ammeter will show a decrease in current.

The big thing to keep in the back of your head is the present drive by the Department of Commerce to curb this violation of wavelength regulations. We amateurs simply must stay within our bands or we run grave risk of losing our licenses. There is to be no further leniency in this respect, so we understand, and the matter is put right into our own hands. Here's hoping some "tickets" may be saved through benefits derived from this article.

S'long, gang, and 73, C U agn.

At the Sign of the Diamond

ABOUT seven years ago the A. R. R. L. adopted an emblem, the now-familiar diamond. It is interesting to note how the idea has spread around the world until now many radio societies have em-



AMERICAN RADIO RELAY LEAGUE (USA & CANADA)



ASSOCIAZIONE DILETTANTI RADIOTECNICI ITALIANI (ITALY)



EMBLEM OF "FRENCH 83" AT PARIS I. A. R. U. CONGRESS



GRUPPO RADIOTECNICO MILANESE (MILAN, ITALY)



DEUTSCHER FUNK-TECHNISCHER VEREIN (GERMANY)



L'ASSOCIATION DES RADIO-AMATEURS FRANÇAIS (BCL, NOT TRANSMITTERS)



ASOCIACION E. A. R. SPANISH SECTION (I. A. R. U.)

blems based on the original concept of a diamond containing radio symbols and the initials of the association. This similarity is pleasing, for it makes the diamond the sign of the radio amateur. We show a few of the devices with which we are familiar. Doubtless there are others, and we would appreciate having our readers bring any additions to our notice. It is probable that when the device of the International Amateur Radio Union is determined upon, it too will be in the diamond family.

—K. B. W.

Strays

The Faculty of Law of Northwestern University (Chicago) administering the income of the Chas. C. Linthicum Foundation, announce a prize of \$1000 to be awarded to the author of the best essay or monograph submitted by March 1 next on "The Law of Radio Communication", the scope to include the aspects of the subject as a problem of international law and as a problem of legislation in the United States. Authors must be members of the bar or students registered in a law school in the United States or Canada. Complete information may be obtained by addressing The Linthicum Foundation in care of the University.

 "Here lies the remains of Raymond Lilter, Who wore his fones while adjusting his filter".

In connection with the article on Breaking into the Amateur Game, in QST for April page 13, the Xmas tree lamps which were used in lieu of a center tap on the filament heating transformer, may be replaced by a 200-ohm potentiometer whose ends are connected to the filament circuit. Two fixed units having a resistance of from 50 to 100 ohms may also be used.

Unusual Set Construction

THE new Sleeper Radio Corporation tuners include several design stunts that are just as good in one wave-band as another, and therefore ought to interest everyone.

To begin with the set is based on a brass panel, to which are secured two cast-iron brackets. These three pieces of metal support every other part of the set. That isn't all; the brackets are rounded off so that the panel, which is hinged at the bottom, can be tilted forward onto the table so as to expose the entire set for convenient inspection and repair. Not even one wire must be disconnected. This should mean something to anyone familiar with the contortions that most sets call for. Amateurs have a way of leaving their sets out in the open to avoid this difficulty but that exposes them to dust and dirt.

To give a better idea of the construction two views are shown. In the first we have the bare skeleton with nothing but the rheostat, filament switch and vernier condenser on the panel. The audio unit is standing by, ready for attachment.

The rest of the description is quoted (almost) from a letter from Robert Hertzberg of the Sleeper Corporation—also of 2FZ. The left-hand condenser tunes the input circuit, control being by means of a

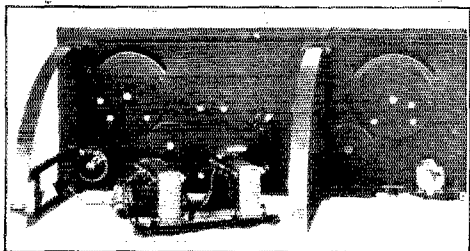

perfectly normal friction vernier. The right-hand condenser is a 2-gang affair, tuning the inputs of the detector and the 2nd R.F. tube. This gang condenser wears one of the R.F. transformers, a thing that has become reasonably common. Note however that the coil has a small diameter, also that the secondary is split and a bunched primary placed between the two halves. The makers are convinced that this construction has a definite advantage in giving the necessary magnetic coupling to the secondary without too much stray field or static coupling. There is room for the theorists to argue here.

The rest of the set goes in by units. One strip carries all the sockets and the re-

maining one (at the back) carries the remaining interstage transformer and the input transformer. This last is of the

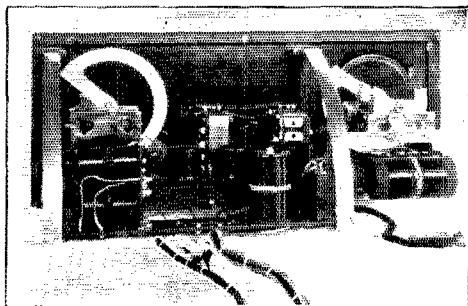

“deformed toroid” variety to reduce pickup from local stations.

Let's see—that's about all except to repeat that the same idea sounds mighty good for any other sort of tuner. Great guns what a lot of trouble it would save if we could all tilt our sets out of the boxes for inspection and repairs—and assemble them on the unit basis.

—R. S. K.

A. R. R. L. Information Service Rules

Please help us by observing the following rules:

1. Keep a copy of your questions and diagrams and mention that you did so.
2. Number the questions and make a paragraph of each one.
3. Make diagrams on separate sheets and fasten them to the letter.
4. Print your name and address (not merely your radio call) on your letter. Don't depend on the return address on the envelope as this is destroyed when the letter is opened.
5. Don't ask for a comparison of the various manufacturers' products.
6. Before writing, search your files of *QST*—the answer probably is there.
7. Address all questions to Information Service, American Radio Relay League, Inc., 1711 Park Street, Hartford, Conn.
8. It is not essential to enclose an envelope as long as you supply postage and **PRINT CLEARLY** your name and address on your letter.

Any back issues of *QST* to which we refer you are obtainable from the Circulation Department for 25 cents each.

Strays

Two new crystal-controlled amateur stations: 6AOI-6ZBN-6CRN and 4WJ.

Improved Transmitting Circuits

SINCE the crystal-control business began many of us have wished for circuits which would give some of the good characteristics of crystal control without the complexity that goes with crystal control whenever one wants an output of more than 3.2 watts. Even with low power a crystal-controlled transmitter is an expensive affair. Therefore both the five watt man and the 50-watt man are bound to be interested in anything that is even partly as good.

In thinking over the things that make a tube transmitter unsteady, L. W. Hatry who

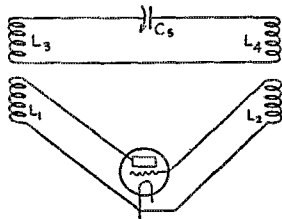

FIG. 1 - 4-COIL MEISSNER

needs no introduction to this gang came to the conclusion that our difficulties were caused mainly by the fact that we have always allowed the tube capacity to become part of the circuit. Since the effective tube capacity changes with the plate and filament voltage nothing could result but an unsteady circuit.

If the difficulty was as suspected caused by feedback thru a varying tube capacity one could get rid of most of the trouble by using a neutralizing system such as the one of Hazeltine (neutrodyne) or the one of Rice (the Rice method). Any feedback that happened thru the tube would then be the result of accidental unbalance and would not amount to much. This idea was immediately tried out on the familiar four coil Meissner circuit of figure 1. In this circuit the feedback is supposed to be from the plate coil L1 to the coil L3 in the tuned circuit. The energy then goes around this tuned circuit and the coil L4 at the other end feeds part of it back to the grid coil L2. This is fair enough at waves above 1000 meters but the further down one gets the more important are the feed backs thru the tube (especially if one follows the common practise of tuning the coil L1) until at about 80 meters the thing generally becomes unmanageable. Now this Meissner circuit is such a very nice thing at long waves that it seemed a shame to have no way of working it at short waves. This neutralizing scheme seemed to provide that

way. A trial showed that the idea was right and the practical form of the circuit (shown in Fig. 2) was extremely steady. The plate and filament voltage can be changed all over the lot without much change in the best note at the receiver, a thing no other one of our transmitting circuits can do. The circuit has all the usual advantages of the long wave Meissner circuit, that is to say the adjustment of wavelength, plate input, grid feedback etc. are all *entirely* independent, within practical limits.

The best way to adjust the circuit is to leave the neutralizing condenser C6 off for a while, also the tuned feedback circuit L3, L4, C5. Begin by connecting temporarily the condensers C1 and C2 across all or part of the coils L1 and L2, depending on the capacity of the condensers you happen to have. Adjust to make the tube oscillate satisfactorily with the two coils L1 and L2 24 inches apart. You now have an ordinary Armstrong circuit. Now connect the condenser C6 and turn it slowly from maximum to minimum noticing the range over which it neutralizes the tube capacity enough to stop oscillations. Set this condenser in the center of this range. Now remove C1 and C2 and bring up the tuned feedback circuit L3 L4 C5. The set should start oscillating promptly with fairly loose coupling between the pairs of coils. If it

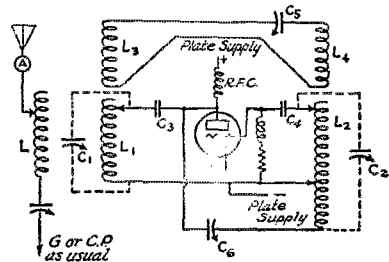

FIG. 2 - IMPROVED MEISSNER CIRCUIT

does not, change the number of turns in L1. Oscillation should stop promptly whenever the coupling between L3 and L1 is loosened. If it doesn't, readjust C6. If the tube capacity is definitely neutralized the tuned circuit has a chance to determine the frequency with accuracy, but otherwise the double feed thru it and also thru the tube can let anything happen.

Fig. 3 is a variation. Here a stiffly tuned grid circuit is used to control the frequency and inductive feed thru L1, L5 is depended upon to sustain oscillation. The tube capacity is neutralized as before by tuning

both plate and grid circuits and then stopping oscillation with C6 while the coupling between L1 and L5 is loose. L5 will be recognized as one of the coils (4 turns used here) out of the tuned feedback circuit of Fig. 2. Hold the key down and remove L5 which should definitely stop oscillation. L5 should always be in the circuit although not coupled to L1 unless oscillations are wanted. This circuit is something between an Armstrong circuit (tuned-plate tuned-grid) and an ordinary plate tickler. It does not look so attractive on paper, especially as it has one more tuning condenser but the circuit does give better steadiness than our more common circuits and is somewhat better than a good Armstrong circuit.

Reforming the Hartly Circuit

The popular Hartley circuit is a harder nut to crack. Since there is only one coil and one condenser the same trick won't answer. For this reason, Hartly went to the method shown in Fig. 4 in which AB is a circuit tuned to the working wave and acting as a filter or rejector. If the working frequency comes from the inductance L6 thru the condenser C2 it might be able

to Fig. 4 without the trap it was reported with a slight wave change while with the trap the wave change was gone. The simplest of the three is Fig. 4, which seems to perform rather well. Listening to harmonics shows a definite gain in all three schemes over any unstabilized circuit and hands the palm for steadiness to Fig. 2.

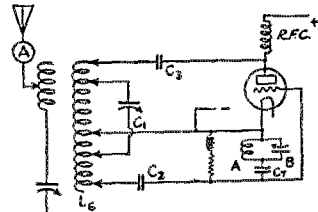

FIG. 4
IMPROVED HARTLEY CIRCUIT

But Fig. 4 is good especially in comparison with the untrapped Hartley. I have no bouquets for any of them because I don't as yet know all that they will do"

The Circuit Constants

Because it is so much easier to start where someone else left off the following values as used by Hatry are given. They are not necessarily final. L is seven turns of edge-wise strip 7" in diameter. C is a 1000 micromicrofarad variable condenser. These two change with the antenna. L1 is 17 turns of 4" diameter edgewise strip spaced a little more than its width. L3 and L4 are four turns each of the same stuff. L2 is 17 turns of 3" diameter stuff. L5 is one of the four turn coils just mentioned and L6 is your present Hartley helix. Coil A depends entirely on the wave length and the size of the condenser B. Low resistance is important here. The condenser capacities in micromicrofarads are as follows: C1 and C2 are 250 but if smaller ones are handier they may be connected across part of the coils L1 and L6 and the coil L2 in Fig. 2, remembering in the last case to include the same number of turns on both sides of the filament tap. Connections to C2 in Fig. 3 must be as shown. C3 and C4 are 200 each. 200 would be plenty at C5 though 500 was used. C6 is 45 maximum approximately, though a 4 or 5 plate condenser may be used. C7 in the present case is 60 micromicrofarads. Depending on the L/C ratio in the circuit AB and also on the resistance of AB, the capacity of C7 must be changed to get proper sharpness in the action of the AB circuit. When A has 8 turns of 4" edgewise strip and B is a 500 micromicrofarad condenser the circuit will oscillate thru 10% of the scale on condenser B if C7 has

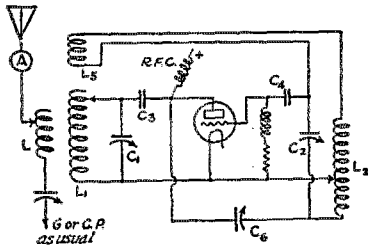

FIG. 3—THE IDEA APPLIED TO ARMSTRONG'S CIRCUIT

to pass thru the condenser C7 but would be stopped by the tuned circuit AB. This frequency therefore must go to the grid and operate it. Any other frequency is more or less bypassed to the filament and therefore has small effect on the grid.

Practical Operation

The present writer has not tried the circuit arrangement of Fig. 4 otherwise his results agree with those of Mr. Hatry who writes as follows: "Which of the three circuits is practically the best I haven't decided. In every case reports have commented on the steadiness of wave in comparison with the same circuit in its usual form. For instance, a slight wave change was commented upon with the tuned plate arrangement, but changing to Fig. 2 resulted in the same man stating that the wave change was gone. The same thing happened

a value of 100 micromicrofarads, but only thru one per cent of the scale if capacity of C7 is reduced to 60. With other traps these values would not hold. Usually the filament tap is central on L2, or almost so. The chokes and resistances are of the usual sort.

The performance of these circuits at 10X and 10A has been encouraging and reports on the results at other stations are requested. Please make them to the Technical Editor or the Assistant Technical Editor, mentioning the wavelength, kind of tube and kind of antenna.

—R. S. K.

Strays

Classy, but inexpensive station call letters can be made with the gold numbers and letters used by the florist for streamers. The call is pasted on a dark background and when suitably framed makes a nice addition to the station wallpaper, says 1BSE.

In speaking of the correct way of totalling messages, the Eighth Edition of the Rules and Regulations of the A.R.R.L. Communications Department says on page 6, "The message total shall be the sum of the messages originated, delivered and *delayed*". So that is the way to get along in the Brass Pounders League!

In extending its service, the OWLS Committee would like two volunteers for Standard Frequency work on the Canadian exclusive frequency band of 5700-5710 kilocycles. These should preferably, though not necessarily, be Canadian stations in or near the eastern part of Ontario or western part of Quebec, and in or near the Prairie or Vanalata Divisions. The requirements would be approximately as given on page 57 of June, QST, except that schedules would be sent on the one frequency only; these would probably occur just before the start of the Wednesday night "prayer meeting". Anyone interested should communicate with K. V. R. Lansingh, temporary address, care Mr. Clark, 1349 Bay Street, Alameda, California.

New Variable Condensers

FOR short-wave work where the capacities in the tuning circuits are small, it readily becomes possible to double-space receiving condensers and still have their overall dimensions within reason. The double spaced condenser has several advantages. There is less danger of warped plates seriously changing the calibration of the secondary and dust and dirt will not accumulate as severely in the wide spaced affairs. The photo shows a new one brought out by Hammarlund in which the plates are spaced twice the normal distance. The con-

denser frame is a solid die cast job having a small piece of hard rubber properly placed to keep the condenser field from butting in at the wrong place. The plates are of brass, both rotor and stator plates being soldered. A full ball bearing is used at the panel end and a ball bearing thrust at the opposite end. An insulated pig-tail is used to make connection between rotor and external circuit. The condenser is of the straight frequency line and is available in

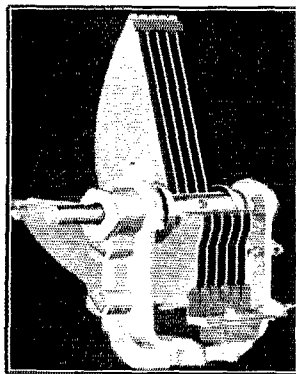

50, 70 and 100 μfd . maximum capacities. The very sizes needed for ham tuners.

The other condenser is a beautiful job showing the design tendency from Canada, this particular one being made by the Canadian Marconi Company. The plates are of brass and are soldered. The end plates are punched from heavy brass stock, the bearings are bronze and the rotor shaft steel. An insulated pig-tail is provided. The general construction is somewhat similar to the General Radio type 247. A ten-to-one vernier is

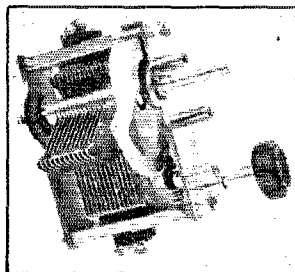

secured through a train of three gears. The smaller gear is die-cut from brass, the intermediate gear is of micarta and the larger gear is cast from brass. This latter gear is so shaped that the unused part does not get in the way of the frame support, a "U"-shaped piece being molded in the gear itself. The condenser is available in one maximum capacity, 500 μfd .

—J. M. C.

Tuning Tricks

By Paul M. Mueller*

IT is to the amateur who has wondered why "matched" condensers and inductances can display such remarkable variability in calibration or who has attempted to build a single control tuner, that this article is presented.

From time to time designers have laid out variable condensers with odd shapes of plates for the purpose of obtaining some peculiar dial calibration. The favorites have been the so-called "straight-line wavelength" and "straight-line frequency" types.

When such design is intelligently handled and all factors given proper consideration the experimental results obtained will agree closely with the theory upon which the design calculations have been based. On the other hand, when the problem is divided between the designer of the condenser and the user (who may easily ignore these little

curve is represented by a simple mathematical equation.

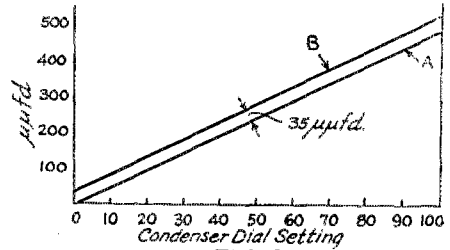

FIG. 3

THE CALIBRATION OF THE STRAIGHT-LINE CONDENSER, USED AS A STARTING POINT FOR THE PROBLEM

- A Condenser alone.
- B Condenser plus other capacities in the circuit.

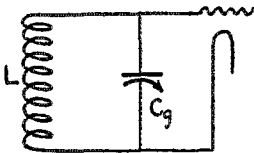

FIG. 1 TYPICAL GRID CIRCUIT

A typical grid circuit is generally represented by a diagram as shown in Fig. 1.

Here we have an oscillatory circuit represented by a pure inductance and capacity and the two electrodes of a V. T. so connected that the variable voltages across the coil and condenser are unpressed on the grid. It is the ideal and simplest case but unfortunately the simplicity is not realized in practice. A better representation of a stage is shown in Fig. 2 where the "ignored factors" are added to Fig. 1. Here we have the pure inductance L and a total circuit capacity C+ equal to the sum of Cg—capacity of condenser proper.

- c—effective capacity from coupled input circuit.
- d—distributed capacity of the coil.
- a—auxiliary capacity.
- v—input conductance capacity of the V. T.

understood factors) things are apt to go wrong.

In a multi-stage R. F. receiver whose stages have separate wavelength controls, it is of little importance that each stage have the same calibration or that the calibration follow the theoretical curve because each stage may be adjusted as a unit to its peak response. However when

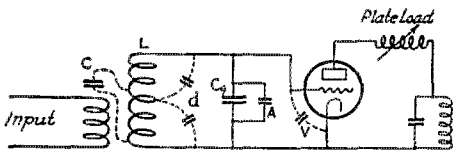

FIG. 2 GRID CIRCUIT WITH "IGNORED FACTORS" ADDED. BATTERIES OMITTED

several stages are to be controlled simultaneously by a single dial it is highly important that the calibration of each stage be uniform, this uniformity being most easily accomplished when the calibration

c. Will vary with the degree of coupling and the type of input circuit i. e. antenna or plate.

d. Will vary with the type of coil winding, spacing, insulation, etc.

v. Will vary considerably with the type of plate loading and may become as great as 40 μfd under certain conditions. (See Ballantine and Van Der Bijl). It is this change of capacity of the tube with plate load which effects tuning when adjusting the tickler in the ordinary regeneration set. For this reason a fixed tickler with a "throttling condenser" is desirable since with this arrangement the plate inductance does not change so greatly. Use a small tickler and a large condenser. Fortunately the pure inductance of several stages

* c/o Pratt & Whitney, Hartford, Connecticut.

may be made nearly uniform by keeping the physical dimensions of the coils closely identical. The same is sufficiently true for several condensers of one make as regards capacity calibration.

The variable summation of total cir-

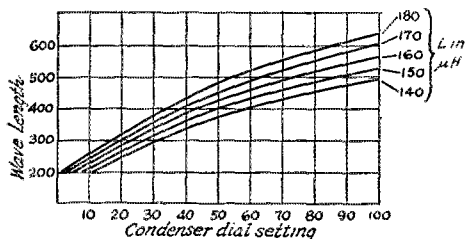

FIG. 4 TUNING CURVES.

THEORETICAL TUNING CURVES OF THE CONDENSER OF FIG. 3 WITH SEVERAL SIZES OF PURE INDUCTANCES

cuit capacity C_t , is constant thru a reasonable frequency change for any given stage provided plate loads and input coupling or effective antenna capacity remain the same. Since the total circuit capacity although constant, differs in amount among

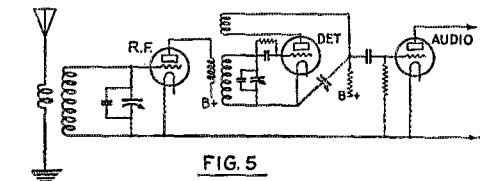

FIG 5

CIRCUIT OF A SUCCESSFUL SET USING THE METHODS DESCRIBED

the several stages, the remedy is found in the addition of a small fixed auxiliary capacity, (A—Fig. 2) to each stage which is complimentary to the other capacities and of such value that the sum $C_g + a + v + d + c = \text{constant}$ which constant is reproduced in each stage. In other words:

$$(C_{g_1} + v_1 + d_1 + c_1) + a_1 = (C_{g_2} + v_2 + d_2 + c_2) + a_2$$

first stage second stage

etc.

When once these auxiliary capacities have been set to the correct value they may be left alone and a single dial used for tuning.

To discover "a" by "rule of thumb" methods in two stages is not easy and probably impossible in three. But it may be easily done by the aid of charts and by building the set so that the single dial control may be added after the set has been completely adjusted as a separate stage controlled tuner.

Start first with the capacity calibration curve of your condensers. In the case of a straight capacity-line condenser the curve will be as A of Fig. 3.

Dial Setting

This curve A represents the variation of C_g or the geometric capacity of the condenser against dial setting.

Now draw curve B at every point an equal ordinal distance above A, a good value for the average being $35 \mu\text{f}$. Curve B then represents the total circuit capacity for any dial setting since we have given a value of $35 \mu\text{f}$ to the summation of

$$C + d + v + a$$

Now draw a chart of wavelength as ordinates and dial settings as abscissae using the value of C_t from curve B, Fig. 3, and several values of pure inductance near the value which will give you the range desired. A chart for the straight capacity-line condenser (max. $500 \mu\text{f}$) and coil of 140, 150, 160, 170, 180 microhenrys inductance is shown in Fig. 4. These curves are conveniently plotted using the W. L. monogram by Harry Etkin in Jan. QST.

This family of curves represents the tuning calibrations of several inductances with the same total stage capacity C_t properly compensated by the correct value of auxiliary capacity "a".

Now calibrate the actual performance of your first stage using either broadcast or variable source of R.F. waves whose lengths are known and plot the result on the family of curves similar to Fig. 4. The calibration will probably have an unfamiliar look and will cross the theoretical curves.

If the slope is less than the theoretical slopes of Fig. 4 reduce the capacity of the auxiliary condenser "a" and increase it if the slope is steeper. Continue this adjust-

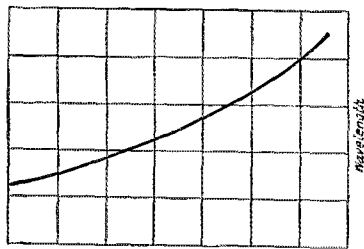

FIG 6

THE TUNING CURVE OF THE SET IN TERMS OF FREQUENCY THIS BECOMES ALMOST A STRAIGHT LINE.

ment until the actual calibration lies within the theoretical family. When this is done the auxiliary capacity is correct, i. e. the parasitic capacities plus the auxiliary equals, the design value of $35 \mu\text{f}$.

The next step is to change the inductance of the coil until the actual calibration coincides with the theoretical curve of the wavelength range desired. (If only 4 or 5 turns must be added or removed it will not

be necessary to readjust the auxiliary capacity).

Now proceed to the next stage and carry

Curve of Fig 6 $\lambda = \lambda_0 a^\theta$ -----①

where a is a constant
 θ is the dial setting
 λ_0 is wavelength with dial at zero
 λ is wavelength to be found at any setting θ

Curve A of Fig 8 $C_t = C_0 a^{2\theta}$ -----②

C_t = total circuit capacity
 C_0 = total circuit capacity when variable condenser is at zero - i.e. when $\theta = 0$

Geometric Capacity

$C = \frac{2248 (N-1)A}{f}$ -----③

$p = \sqrt{\frac{4C_0 a^{2\theta} \log_e a + r^2}{f}}$ -----④

where C_0 = parasitic capacities
 r = inner radius of plates
 θ = dial setting as before
 a and f depend on condenser and dial structure as explained in text
 p = variable outer radius shown in Fig 9

FIG 7. EQUATIONS

through the calibration and adjustment in the same manner bringing the final calibration in line with the desired theoretical curve.

The third stage ought to work out in the same manner but the author will only vouch for two having used up all his patience at this point.

When this adjustment is complete (by all means leave everything alone) assemble the single control mechanism without disturbing the relationship of the parts of the

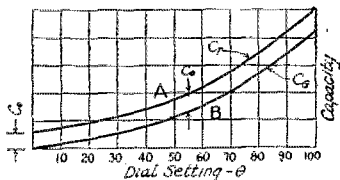

FIG 8

THE CURVE OF THE CONDENSER NEEDED TO GIVE THE TUNING CURVE OF FIG. 6

From this curve is calculated the plate shape in Fig. 9.

- A Circuit capacity referred to
- A Total circuit capacity C_t .
- B Capacity of condenser alone, that is C_t less C_0 .

set. If condensers must be removed they should be carefully handled and should not

be returned to a new position which effects the coils or the wiring appreciably.

The circuit of a successful set following these ideas is shown in Fig. 5. The double condenser was built over from two old Cardwells.

The desired calibration for wavelength is shown in Fig. 6 the equation for the curve being No. 1 in Fig. 7. This curve is such that the rate of change of tuning is proportional to the wavelength and is our old friend the "decremeter curve". It is not very different from the curve of an "S.L.F." stage.

The calibration for the total circuit capacity is deduced from equation 1 (Fig. 7) and is given in equation 2 of the same figure. The graph of equation 2 is the curve A of Fig. 8. The curve B on the same figure is the geometric capacity of the variable condenser itself. Since the area of the plates in engagement is a linear function of the condenser capacity C_g , it is possible to assume a fixed internal radius for the system and to calculate the outer radius. The resulting equation is given as No. 4 in Figure 7 and the plate corresponding to this equation is shown in Fig. 9. Equation 4 represents the value of the outer radius of the rotor blades in terms of the parasitic ca-

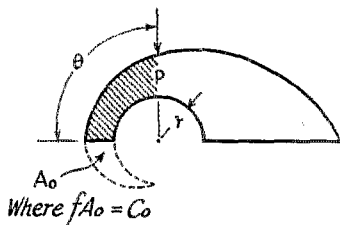

FIG 9

A CONDENSER PLATE CALCULATED FROM THE CURVE B OF FIGURE 8

capacity value C_0 of the stage, the inner radius r and the dial setting θ . The value of f depends upon the physical dimensions of the condenser (number of plates and thickness of dielectric) and is derived from the equation for geometric capacity, no. 3 in Fig. 7. The value of a is a percentage constant and depends upon the number of divisions in the half circle used on the dial. The dotted area of Fig. 9 is of interest. It is the continuation of the plate's curves and would need to be represented in metal were it not for the parasitic capacities whose sum equals it in effect.

A double condenser such as described can be built to an effective total circuit capacity of 200 $\mu\text{f.d.}$ using standard 500 $\mu\text{f.d.}$ semi-circular Cardwell variables.

Operating Receiving Filaments Without Batteries

By Robert S. Kruse, Technical Editor

PERHAPS all of us have been irritated by the great enthusiasm of manufacturers for the elimination of B batteries, without any appearance of equal enthusiasm for the elimination of the real nuisance—the filament battery and the charger.

The chances are that not very many have had the thought that the A-battery eliminator actually exists if one is using 199 tubes, and is willing to re-wire the set. It is only necessary to connect the filaments in series, then to feed them from a B-battery "sub," with a suitable series resistance if one is needed. That this scheme is entirely practical is shown by the fact that it is being done in the Radiola Superheterodyne sets. There are several of these combinations on the market but they all depend on a rather husky "B-sub" with a low-resistance filter so that it is possible to draw 120 mils or so. In one combination the field coil of a loud speaker (the type 104) is used as the filter choke. UX-199 filaments are not very brilliant at the best but if one of a series burns out they are very much dimmer. Then it is a real problem to find out which one "went west."

the owner of a superheterodyne with 199 and 120 tubes. Most of us are not that prosperous and use fewer tubes—and these are generally of the 201-A type. The ordinary B substitute will not supply a quarter

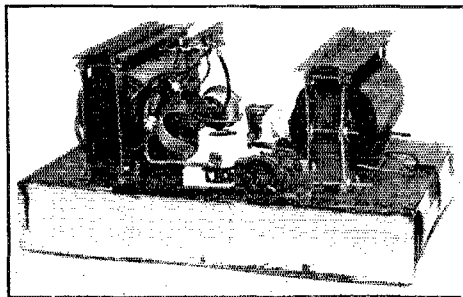

INTERIOR CONSTRUCTION OF THE "RECTRAD"

The power transformer is at the left, tungar socket at center and the choke L1 at the right. This is the equipment to the left of the points AA in Figure 2. The 48 microfarads are in the base.

of an ampere, much less the current required by several tubes in parallel. However the thing *can* be done for both broadcast and C. W. receivers, and this is our story.

Filaments in Series

There is no use in making the problem any harder than necessary. For that reason we will assume that you are going to use 201-A filaments in series or else just a few 199 filaments in parallel. In other words we are going to assume that you will not need more than $\frac{1}{4}$ of an ampere. This is probably not going to do much good for the set you already have unless you are willing to rewire the filament circuit. In doing that you will have to be careful to make your grid return to the right filament in the series. This is really a great advantage because you can do away with C batteries entirely. There is no need to give more exact instructions than this. You know what the drop across each filament is, you know what bias you want on each grid and it is a matter of arithmetic to find the proper place for each grid return.

A Practical A-and B- Battery Substitute

There are on the market several "A and B substitutes" which contain an A-battery with a trickle charger, also a rectifier-and-filter for the plate supply. The thing I am referring to here is based on the idea that one wishes to do away with batteries entirely. There are two ways of going at

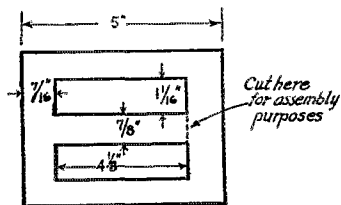

FIG. 1

POWER TRANSFORMER OF THE "RECTRAD"

Core is of 29 gage transformer steel stacked $\frac{3}{8}$ inch high. The same core is used in the chokes of the Rectrad and the Multiplex receiver, using the windings indicated in Figure 2. Transformer Primary. 876 turns No. 23 enameled, tapped at 823 and 770. Secondary 1990 turns No. 25 enamel, tapped at center. Tertiary (filament) 32 turns No. 10 D. C. C. tapped at center.

In the superheterodynes referred to above there is a simple answer to the problem; each tube is shunted by a resistance taking half the current, i.e. the resistance takes 60 mils and the tube takes 60 mils. The last audio tube, being a UX-120 takes the entire 120 mils. If any of the 199s burns out the rest of the tubes burn almost as usual, if the 120 goes out the whole business is dark—really quite simple.

Now that sort of thing is all very well for

this thing. One can replace the A-battery by a low voltage rectifier-and-filter (a true A substitute) and provide a small current high voltage rectifier-and-filter. (B substitute) for the plate supply. This is rather complicated and expensive and as a rule it is better to provide one rectifier and filter giving a current large enough for the filaments and a voltage high enough for the plates. It is of course, necessary to waste

"The drop in the Tungar is not so high as that in the filter. The over-all voltage of B is about 300.

"The rectified output goes into the first big condenser having a capacity of 24 microfarads, then thru the first choke and then into the second condenser, also of 24 microfarads capacity.

"This much of the system may be removed and the rest of the equipment (which is a

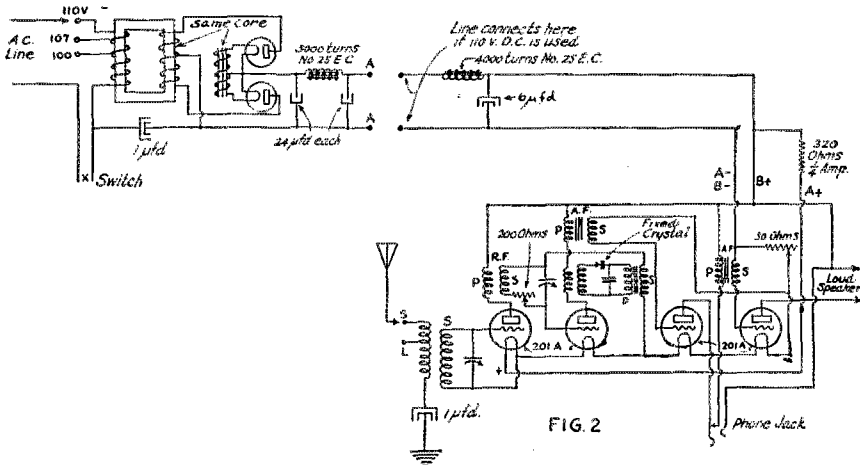

THE CIRCUIT OF THE RECTRAD

Shown with the circuit of the Multiflex receiver for completeness. The circuit to the left of AA is that of the Rectrad. The circuit to the right of AA includes the auxiliary filter which is used for both D. C. and A. C. operation, also the fixed resistor which dissipates about twenty-five watts. The circuit of the receiver is that of a normal reflex excepting that no C batteries are used, as the biases can be obtained conveniently by returning to the proper point of the filament circuit. The note that one side of the transformer primary is connected thru the A minus thru a condenser. This, and possibly reversal of the connections to the line assist greatly in obtaining quietness. Note also that inside of the set the connections between the filament circuit and ground is made thru a protective condenser. The loop jack has been omitted to simplify the diagram.

some energy with this arrangement. A number of such devices have at various times been made and it is likely that the development will continue. An interesting device of the type now on the market is the "Rectrad," made by the Radio Receptor Company, Inc. Mr. Victor Greiff, electrical engineer for the company, has been kind enough to furnish constructional details and wiring diagrams of the device, as follows.

"The device is based on the standard two-ampere Tungar rectifying tube. The output of these tubes is far below their rating in this circuit being just a little over 1/4 ampere. The lamp cord feeds the primary of a liberally designed transformer whose dimensions are given in figure 1. This transformer has a primary, tapped to suit the line voltage and two secondaries, (A)—center tapped filament winding for the Tungars. (B)—center tapped winding for rectification to give 110 volts rectified output at .27 amp. after the drops in the chokes and tubes have been subtracted.

set designed to operate on 110 volts D. C.) may be connected directly to a 110-volt D. C. line.

"After this (points A. A. in figure 2) comes another choke like the first followed by a 6-microfarad condenser. The current has now been sufficiently smoothed for use as plate supply and a portion is used for this purpose. The larger part goes thru the 320-ohm fixed resistance and the 50-ohm rheostat to the filaments, which are connected in series as shown in figure 2.

"The choke has a silicon steel core, with a small air gap, and the windings are plentifully layered with paper to keep down the capacity transfer. All the condensers are housed in the bottom of the Rectrad and the incoming and outgoing connections provided by standard electrical fittings.

"The Rectrad and filter (to the left of AA in Figure 2) can be used with any hook-up properly laid out with 201-A tubes in series.

"We have not had any considerable trouble with A. C. ripple getting into the set via

filament or plate circuit thru the filter but we have found about a hundred ways that disturbances can be induced or conducted into the set. We have licked most of them but there is no royal road to filtering. It takes detail work. Commutator motors on refrigerators and magnetos or transformers on oil burners create disturbances that can be stopped at the Rectrad input but come in anew via antenna or loop. (The pleasing fact is that the manufacturers of these devices are beginning to shield them thoroughly.—R. S. K.)

"In order to protect the Tungar bulbs from over-potential, we find it desirable to switch the transformer primary right from the panel of the set, and not break the filament circuit. This is done by a rather ingenious arrangement of cords and plugs, so that any D. C. Multiflex set may be attached to a Rectrad and the switch which originally controlled the D. C. then interrupts the transformer primary."

Tubes for the Purpose

When UX-199 tubes are being used there is no sense in a large and expensive filament battery substitute. The whole thing can be made much cheaper and more compact by using the "trickle charge" variety of Tungar and by cutting down the size of the chokes. Of course this does not mean cutting down the inductance but simply that one can stand more resistance when drawing a smaller current.

The Raytheon tube may be used with slight overloading, as may the Westinghouse

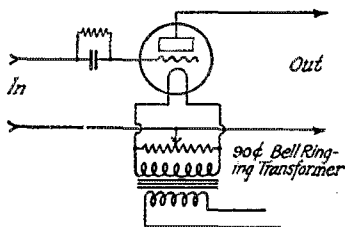

FIG. 3

OPERATING FILAMENTS OF C. W. RECEIVER ON A. C.

The potentiometer should have a resistance of 400 ohms. If UX-199 tubes are used complete quiet cannot be gotten on the 60-cycle and 180-cycle hum at the same setting. With large tubes the 180-cycle hum makes no trouble.

and General Electric rectifier tubes originally made for B-battery substitutes. Only the Tungar tube mentioned in the previous paragraph will operate the filaments in parallel, but there is some possibility that we will shortly have a low voltage quarter ampere gas rectifier tube.

The C. W. Set

Fortunately the C. W. set is not as critical in its demands as the broadcast receiver,

therefore the filters described can be cut down a great deal for oscillating reception. Rather decent results can be gotten with a 30-henry choke and a pair of two microfarad condensers, which isn't much of strain on anyones finances and is certainly cheaper than the battery, charger, and hydrometer.

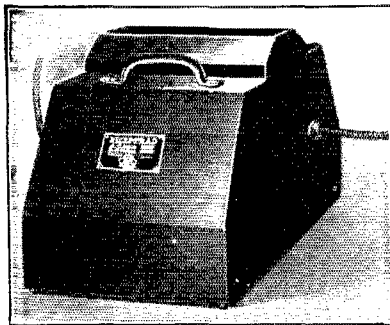

THE "RECTRAD" IN ITS HOUSING

One caution, however, the transformer supplying the affair *must* be several feet away from the receiver and may possibly need a shielding winding between the primary and the other two windings. This shielding winding is simply a single layer of wire, left open-circuited and with one end grounded to some convenient pipe or wire.

I have used such a contrivance intermittently on a short wave receiver with detector and two stages of audio. The thing has not even a shielding winding and the rectifier tubes have been of different kinds from time to time, therefore the results have naturally not been perfect. Nevertheless, the thing is a great convenience and works nicely, except when there is a "power leak" in action. On these evenings the batteries are better but I am inclined to think that shielding and R. F. chokes would cure most of that. It works fairly well even under bad conditions.

Filaments on A. C.

When one comes right down to it the real thing would be to get rid of the rectifier and the filter as well as the batteries. This is really getting into the field of the "thimble" ube which is not the present intention. However, ordinary filaments can be operated on A. C. under some conditions. In a C. W. receiver it is possible to do very decent receiving when operating both the detector and audio filaments from a bell-ringing transformer in the circuit shown in Figure 3. The detector and audio amplifier should have separate potentiometers. These are adjusted to get the least possible hum which of course, means that the grid bias is wrong and must be supplied from a C-battery. The

detector can get along with a grid leak and condenser. This sort of an arrangement is best with a thick filament in the tube, in other words a UX-210. However, a portable receiver using a pair of UX-199 tubes worked very well after one got used to a steady hum in the background. The use of a pair of phones with small diaphragms toned this hum down a great deal.

The Audio Filaments

In sets having both radio and audio frequency amplifiers it is sometimes possible to apply the circuit of Figure 3 to either the radio or the audio filaments but generally not to both. Almost always it is possible to work the scheme on the last audio filament, especially if that be one of the overgrown audio amplifier tubes, which have lately appeared. Of course the operation of these tubes, such as the UX-112, UX-171 and UX-210, on alternating current is no particular novelty and has in fact been built into quite a few receivers presented by various magazines recently.

However, the idea was not to present something novel or to "revolutionize radio" but simply to present some notes on a little progress in a useful direction.

The Davy "A" Substitute

Originally this article ended with the preceding paragraph but it happened that QST's space was limited so that it has been held over for a month during which time the writer has had an opportunity to try a battery substitute which operates the filaments of 201-A tubes (as many as 8 of them) in parallel.

Here we have a device that will operate a normal receiving set without any rewir-

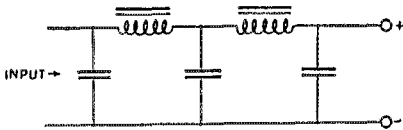

FIG 4
GENERAL TYPE OF FILTER CIRCUITS
USED IN B SUBSTITUTES

ing which, regardless of what the ultimate set may be, is a most important consideration for the owner of sets already built.

Through the courtesy of Messrs. Levine, Roeder and Lilienfeld of the Davy Electrical Corp., several of the substitutes were lent to the writer who tried them under practical conditions with both continuous wave and broadcast receivers. The latest model of the device has been in use with a representative broadcast receiver for a number of weeks and has during that time developed no undesirable characteristics.

A descriptive article prepared by Mr. E.

M. Roeder, Chief Engineer of Davy Electrical Corp., was unfortunately received at so late a time that it is possible only to use a portion of it here. Frankly, I think the article in its entirety would have very nicely replaced what I have written.

The "A" Substitute Problem

By E. M. Roeder, E. E.*

IT seems at first that the general scheme of "B" eliminators should be applicable to the "A" supply. It is, but a number of difficulties are encountered which are not present in the problem of B-elimination.

In the first place, the B-eliminator furnishes a supply of energy of com-

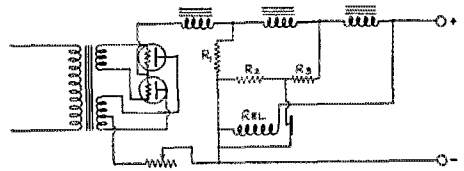

FIG 5
CIRCUIT OF THE DAVY A-SUBSTITUTE

At the left is the transformer which has three windings. The filaments are operated in series and a center tap taken between them. The output of the substitute is regulated by the variable resistance in the negative lead. A normal load is kept on the rectifier by means of the resistance R-1. When the load on the device is reduced the relay Rel. is operated by the increase voltage and its contacts connect in the resistances R2 and R3 which act as additional load and limit the rising voltage. A fixed resistance, not shown in the diagram, protects the device against overloads. It can be short circuited for a time without injury.

paratively high potential and low current. The ordinary filter system employed consists of one or more stages of choke coils and condensers arranged as in Fig 4, and simple mathematical considerations will show that in order to be of appreciable usefulness the A.C. impedance of the filter condensers must not be more than one half of the impedance of the chokes. In practice this ratio is usually from 1/20 to 1/100. The chokes carry comparatively little current and can be made of high impedance because of this fact. The usual inductance is from thirty to eighty henrys, and the capacitance from eight to sixteen microfarads.

Unfortunately, however, inductance values of the order of thirty to eighty henrys are out of the question when currents of 1½ and 2 amperes are to be carried. The chokes would be as big as the family ice box and would weigh as much as

* Chief Engineer, Davy Electrical Corp'n.

a husky kitchen stove. Inductance, however, we must have, so we use as much as we conveniently can, and stop there.

Naturally the A.C. impedance of a choke such as we can use is comparatively low, and in order to satisfy our requirements of even lower condenser impedance, it is obvious that a huge condenser bank is required. The total capacitance is enormous in the order of several thousand microfarads—and, needless to say, is out of the question.

Dr. J. E. Lilienfeld, discovered, however, that it is possible to design an effective filter without capacity, and a new filter circuit,

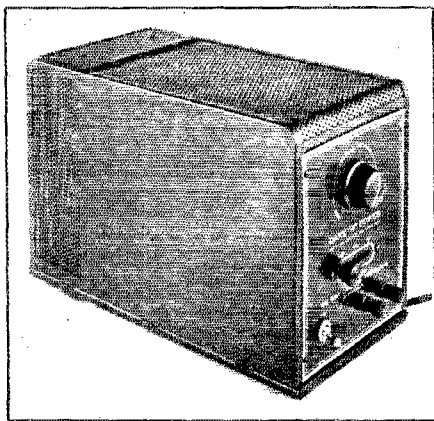

THE DAVY A-SUBSTITUTE

The rectigon bulbs are located in the ventilated rear compartment which is separated from the rest of the apparatus by an asbestos-board partition. The main compartment houses the transformer, protective relay and filter. On the control panel the upper knob operates the master rheostat which is used in place of the rheostat on the set. The sliding knob at the center of the panel is an adjustment for different line voltages.

adaptable to these conditions is now made possible. This new circuit makes use of resistance instead of capacitance, and is arranged as in Fig. 5.

The Davy "A" Power makes use of this system. Both halves of the cycle are rectified, by means of two Rectigon bulbs, and the output is filtered by means of Dr. Lilienfeld's inductance-resistance system so that the 120-cycle ripple is reduced about 1800 or 1900 times. A rheostat controls the output, and any voltage up to six may be obtained. Receivers with from four to seven tubes are operated with no hum, and in some cases sets having as many as ten tubes of the 201-A type may be successfully supplied with filament current.

An underload (or overvoltage) relay is incorporated in the device, preventing any tendency for the voltage to rise unduly when a portion of the load is removed. This re-

lay automatically cuts in a resistance across the output of the Rectigons, compensating for the reduction in the load and holding the terminal voltage at normal.

The receiver is connected in exactly the same manner as if a storage battery were used, and is operated exactly as usual, except that the rheostats of the set are turned up full and left there. The control of the filament brilliancy is embodied in the A Power, and once set, need never be changed. The set is switched on and off at the A Power, and the terminal voltage is constant at all times. Provision is also made to compensate for variation in local line voltages.

For broadcast reception, the usual antenna and ground connections are employed, but for the low waves, it may be found that the ground provided by the capacitance of the instrument windings to earth through the primary windings and the power lines may be of more value than the usual ground connection.

For amateur work, especially with the new "peaked" audio transformer, this rectifier system is ideal, and the broadcast listener's battery and charger troubles are easily and conveniently eliminated.

Strays

Cliff Dow at NPU-6ZAC has been using the same old 203 transmitting tube for several years under heavy and almost continuous operation. He uses the scheme shown in the illustration to water and oil cool it. The tube is suspended in a two gallon jar filled with transformer oil. The

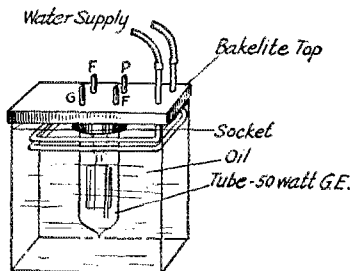

oil is cooled by a two turn coil of one half inch copper tubing through which water circulates. Cliff says that the tube does not heat a bit, although the poor devil is working hours at a stretch.

9ZT sez that he fell off the top step of his 114-foot mast several years ago. He wasn't hurt either because it was Spring time.

Straightening Out the Antenna

By Benjamin S. Melton*

THE following article is intended to straighten out our ideas on radiating systems in general, to show why a grounded antenna can only be operated on a so-called "odd-harmonic," to suggest that a simple radiating system is probably the best, and to show how to get the juice into the antenna in such a way that the antenna will be given a chance to throw it away most efficiently.

In the first place, it will simplify matters if we stop talking of antennae operating on their fundamentals, even or odd harmonics, etc. Such terms, while they may have meaning, tend to confuse our ideas, and prevent us from seeing the true conditions in a given radiating system. The terminology used in this article represents present day commercial practice. It will be seen that this terminology is logical and presents a clear mental picture of what happens in the radiating system.

The Possible Antennae

Let us take a certain wave, such as 10 meters, and show some of the possible radiating systems, considering only such systems as are composed of a single conductor, either connected to earth or isolated. We shall see how this wave can be radiated from various antenna systems fulfilling certain conditions.

In the first place, (for resonance) the antenna system must have a physical length which is an integral multiple of a quarter wavelength.

Fig. 1 illustrates the various lengths of systems, and also the names of these various lengths. The voltage distribution on these systems is shown also. It will be noticed that the "free" end of any system must have a voltage loop, or peak, as it has a current node at this point. No current can

flow to or from a "free" end to ground (neglecting insulator leakage).

It may be seen from Fig. 1 that the systems which are an odd number of quarter waves in length *must be grounded at one end*, as they have current loops (corresponding to voltage nodes) at that end. A current must therefore flow to or from that end to the ground. Furthermore, it may be seen that the systems which are an even

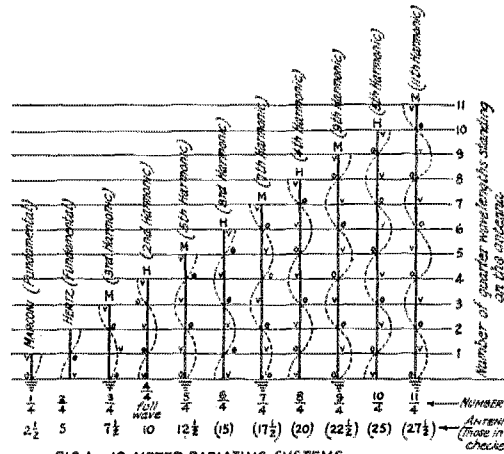

FIG. 1 - 10-METER RADIATING SYSTEMS DRAWN TO ILLUSTRATE POSSIBLE METHODS OF OPERATING BOTH GROUNDED AND UN-GROUNDED ANTENNA

The designations at the base of the antenna are those suggested by the author while the ones at the top are in accord with usual amateur practice. Note that the grounded systems can be operated only with an odd number of quarter waves standing in on the antenna while the ungrounded systems can be operated with either an odd or an even number of quarter waves standing.

The dotted lines show the voltage distribution. The points "O" are the voltage nodes (current loops) at which "current feed" can be used to best advantage. The points "V" are the voltage loops (current nodes). Voltage feed must be applied at the points "V" or at least not too far from them.

While the antennas shown are vertical it is possible to operate the ungrounded ones in any position. Both the grounded and the ungrounded ones may be bent instead of straight.

number of quarter waves in length *must not be grounded at either end*, as a high voltage

2 Is it not surprising that this can be said without starting a violent argument. A few years ago when spark sets were universal almost all antennas were made small for the wavelength and operated with loading coils. This gave very large antenna currents and there are many old texts and governmental publications that advise operating with an antenna of the proper size to give the largest antenna current. Ballantine was perhaps the most active campaigner in this belief and gradually we have gone over to antennae large enough to be operated unloaded, or even to be operated at a harmonic—a statement I am unfortunately not able to put into the suggested terminology of the author.—Tech. Ed.

* General Electric Co., Schenectady, N. Y.

1 There is room for argument here. When we refer to closed oscillating circuits inside the station it is constantly necessary to speak of the harmonics that are present in them. It seems exactly as reasonable to refer to the harmonics of the open circuit outside the station—and one set of terms answers for both purposes.—Tech Ed.

from a point to ground cannot exist when the point is grounded.

Horizontal Antennae

Remember, also, that these systems can be made horizontally³, except that in such a case it is not possible to ground one end *definitely*. Any wire run from one end of

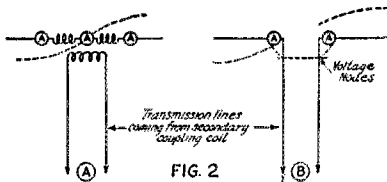

FIG. 2
CURRENT-FEED SYSTEMS

- A. Feed line with transformer at the antenna. See text for construction.
- B. Feed line without transformer at antenna. Both cases should have a transformer at the station end of the line.

the antenna to the ground would form part of the radiating system itself. Thus (for horizontal antennae) we are limited to systems an even number of quarter waves long.

Bent Antennae

So far we have talked about straight antennas entirely. The straight (or linear) antenna was first used by Hertz who worked entirely with vertical ungrounded systems which were put in all sorts of positions—vertical, horizontal and slantwise. Marconi probably introduced the use of the ground connection—though there is some argument about this. These are the systems marked “Hertz” and “Marconi” in Figure 1.

Now these systems become pretty large if we are to work at any but the shortest wavelengths and therefore with wavelengths above 40 meters we usually have antennas which are bent over to keep from using large and expensive towers. If such an antenna works with a ground connection it is a modification of Marconi’s original scheme. It may operate with a ¼ wave standing on it or may operate in any of the ways which have an ODD number of quarter waves on the antenna—in other words it can work in any of the ways marked “M” in figure 1.

Bent Antennae with Counterpoise

If a bent antenna is worked with a counterpoise it is hard to say what type we shall classify it under. It is a double-ended affair like the Hertz antenna, yet one end is

connected to the earth, (thru the counterpoise-earth capacity) which is a resemblance of the Marconi scheme. If the counterpoise is large and near the earth it is almost a Marconi-type antenna but if the counterpoise is small and far above the ground the thing is almost a Hertz-type antenna. Some German writers get around this difficulty by referring to bent antenna-counterpoise systems as “Braun antennae” because Braun seems to have put them into commercial use first.

The name is not so important as the method of operation. Unfortunately this is not a thing about which one can make a simple statement as in the previous cases. If the counterpoise is very large it will act (as mentioned before) as a series condenser in a grounded system and the antenna will operate with an ODD number of quarter waves standing on it, just as shown for the “M” antennas in Fig. 1. Such counterpoises are unusual in amateur work although there have been some—for instance the great wheel-counterpoise at SAQO in Cazenovia, New York. The voltage-to-ground was very small with that C. P., even when several kilowatt were being fed to the antenna. The C. P. could be touched without danger.

With the more usual amateur counterpoises the capacity to ground is very small and the system operates with an EVEN number of quarter-waves standing on it—there is voltage at both the antenna top and the C. P. ends. This means that the system works in one of the various ways labeled “H” in Figure 1.

The waves on these radiating systems are known as “standing waves.” This simply means that points of zero potential (nodes) and points of maximum potential (loops), do not move along the wire in the direction of its length.

Feeding

Suppose now that we wish to excite any of these systems. There are two general methods of excitation or “feed.” The first is “current feed,” usually through electro magnetic (inductive) coupling. The second is “voltage feed,” usually by means of electrostatic (capacity) coupling. Either of these methods may be used with any radiating system provided the current feed is not attempted at a current node, nor the voltage feed at a voltage node. See Fig. 1.

It is not necessary to use a voltage feed exactly at a voltage loop, nor a current feed at a current loop, though it is usually more convenient, and tends to give less trouble in practice, especially in the case of the current-feed.

To illustrate the two types of feeding we shall consider the half-wave antenna, in a

3. For some unknown reason amateurs have begun to call the horizontal linear antenna the “Hertzian antenna”. Hertz’s antennae were quite as often vertical as they were horizontal. “Hertzian” had best be kept to mean a straight antenna without much (if any) loading absolutely regardless of the position the thing may have.—Tech. Ed.

horizontal position, and more than about one half wavelength above the ground.

Current Feed

First we shall consider current feed. There are two methods in this case, as shown in Fig. 2, though they amount to the same thing. The advantage of the second arrangement is that the antenna can be tuned somewhat from the station end of the transmission line, though such tuning shifts the voltage nodes (the single node has been split in two by the introduction of the transmission line) either out along the antenna, or down on the transmission line. It may be seen that this arrangement becomes a partial voltage feed when the voltage nodes are shifted.

Voltage Feed

We shall now consider voltage feed. One method of obtaining this is shown in Fig. 3. Though a small capacity is shown for this method, and inductance may be substituted, or the wire leading from the oscillating tuned circuit may be continuous. The requirement for correct operation is simply that there be a voltage loop or peak at the end of the feed wire. The meter in the antenna will be at a maximum when this is so. Sometimes the feed wire happens to be of the correct length to build up such a peak, sometimes an inductance or capacity is required to put the voltage loop at the correct point. It may be seen that if the feed wire itself is of the correct length for a voltage loop at its top, it will form part of the radiating system.

The single feed wire need not necessarily be connected to the end of the antenna, but instead may be connected almost anywhere between the end and the middle, although at any point between the end and the middle it forms a combination current and voltage feed.

The straight half-wave antenna is generally admitted to be the most efficient radiator, but this *does not* necessarily mean that it is the *best antenna* to send the energy over long distances, as it may not send it at the proper angle for best results. From consideration of theoretical angles of propagation, and from very meager experimental information, it is my personal opinion that the full-wave vertical antenna may be one of the best radiating systems for short waves.

Transmission lines used to feed antennae have many advantages, and should be used more generally than they are. Put the antenna where it will be away from other conductors, place the set where convenient, and run a transmission line of any length necessary between the two. As long as the line is well insulated and the wires not spaced too far apart (four to ten inches is

O. K.), the line will not lose much energy through conductive leaks or radiation.

When coupling into an antenna by means of a transformer as shown in Fig 2A, the ratio of the primary turns to secondary turns should be the square root of the ratio of the surge impedance of the line to the resistance of the antenna, *provided* the prim-

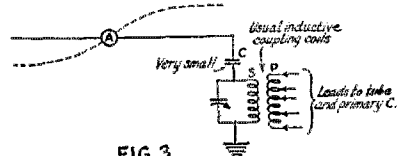

FIG. 3

A VOLTAGE-FEED SYSTEM

While the feeder is shown connected at the voltage loop (see Fig. 1) it can be connected at a point nearer the node and this is frequently done in practice. In this figure and figure 2 the antennas may be vertical, horizontal or slanting.

ary and secondary are very closely coupled. (Unity coupling to make this statement exactly correct). The surge impedance of a

no-loss line is equal to $\sqrt{\frac{L}{C}}$, and does not

change much for any ordinary line, being on the order of 600 ohms. The resistance of a straight half-wave antenna unloaded is about 100 ohms, provided the antenna is some distance from the earth and other conductors, and has no large lumped inductance or capacity. Hence a good transformer turns-ratio to start with is about $2\frac{1}{2}$ to 1. That is, for one turn in the antenna, use between two and two and one-half turns in the end of the transmission line, provided all turns are about the same diameter. The coupling between primary and secondary should be as close as can be obtained*.

* Do not confuse this with the transformer at the station end of the line. Excessively close coupling at that point will result in the usual interference difficulties.—Tech. Ed.

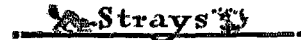

We desire to call to the attention of the experimentally inclined readers of *QST* a magazine which they, by all means, should be seeing, and that is *Experimental Wireless and the Wireless Engineer*, published at Dorset House, Tudor Street, London, E. C. 4, England. This magazine is always chock-full of very interesting information both of a theoretical and a practical nature. It is the official organ of the Radio Society of Great Britain and is something you really should not be missing. Incidentally it costs only 15 shillings a year and can be obtained from the above address.

A 20-40-80-Meter Crystal-Controlled Transmitter

By L. B. Root*

THE development of the piezo-electric effect of quartz is perhaps one of the greatest improvements in radio transmission since the vacuum tube. Speaking from the viewpoint of the amateur, it solves the problem of swinging notes, and makes possible the reading of very weak signals because of the steady, clear-cut quality of the quartz plate-controlled transmitter. In the vicinity of 40 meters, a change of 2/10 of one percent in the trans-

mitter that performs well, is not difficult to construct, and is semi-portable.¹

General Description

The transmitter proper consists of two tubes, one UX-112 and one UX-210. The first, which is the oscillator tube, is quartz controlled at 1874 Kc. (160 meters) and the second harmonic is picked out by a tuned circuit for impression on the grid of the amplifier tube at 3748 Kc. or 80 meters.

This frequency is again doubled in the plate circuit of the amplifier and the 7496 Kc. or 40-meter output is used to feed the antenna-counterpoise system. It will be shown later that with slight changes, transmission may be had on 20, 40, or 80 meters with the same quartz plate.

There are two rectifiers, one a full-wave set using two UX-216-B tubes which provides plate current for both the oscillator and the amplifier; the other a half-wave set with a 201-A to supply the C-voltage for the amplifier. A resistance of 12,000 ohms in series with the oscillator plate reduces the voltage to a suitable value. The various voltages and currents are: oscillator, 175 volts, 25 M. A.; amplified plate, 500 volts, 60 M. A. (while excited) amplified grid 125 volts.

The rectifiers occupy the base-board and lower half of the panel, while the shelf and upper half carry the oscillator and amplifier tubes, meters, switches and tuning elements.

Detailed Description

For the benefit of those who wish to make their own parts, or adapt some that they have already made, brief details of the various components will be given.

Helices—L1, oscillator plate coil, 28 turns. L2, amplifier plate coil, 20 turns; both wound with No. 14 wire on 3" hard rubber threaded tube, threaded 8 to the inch.

Tuning condensers: C1 & C2, General Radio type 247, maximum capacity, 250µufd., (2 required).

¹ The set may look to be very costly but this is not entirely correct. A rough estimate of costs shows that the set may be reproduced for a total expenditure of about \$190, no more than is put into many sets not as good or as flexible.—Tech. Ed.

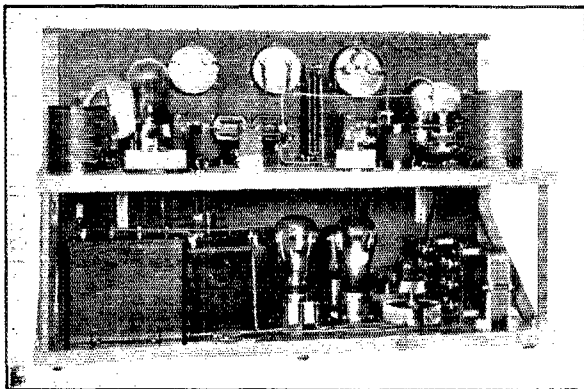

Back view of the set. On the upper deck at the right is the oscillator LC circuit, then the oscillator tube with the crystal mounting between it and the reader. To the left of the tube may be seen the grid-circuit R. F. C. also the mounting for the coil L4 which coil is plugged out to show the A. C. voltmeter switch. This coil is wound on the standard General Radio plug-in coil form. Next is a meter resistance, the milliammeter, the coupling condensers C5 and then (closely grouped) the amplifier grid choke, resistor R3, plate voltmeter switch and plate voltmeter. At the left is the amplifier tube with its rheostat and LC circuit.

mitted frequency will change the beat note in the receiver beyond audibility. Another advantage, is that with quartz control, a rather poor source of plate voltage may sound well on the air. This does not mean that raw A.C. will be as sharp as a storage battery supply, but with only a fairly good filter on rectified A.C. the output will be much better than could ordinarily be expected.

The transmitter to be described was adopted as the final model after experimenting with several others, somewhat different in design. It is not presented as the acme of perfection, but it is a good workable set

* Laboratory, General Radio Co., Cambridge, Mass. also owner of IKF.

R.F. Chokes: (marked "RFC" in diagram) 100 turns No. 30 D.C.C. on 1" form (3 required).

Center tap resistance R: About 100 ohms of No. 40 resistance wire on either side of a center tap, (4 required). Each half of each resistor is by-passed by a Sangamo fixed condenser capacity .001μfd., (4 required). None needed on rectifier filaments.

Transformers: To permit the use of two transformer cores of the same type one-half of the B-rectifier supply winding was put on each core as shown in the diagram. The cores are General Radio type 273 and the windings are as follows:

Coils K—110-volt primary, 800 turns No. 24 enameled.

Coils L—8-volt filament secondaries, 62 turns No. 17 D.C.C.

Coils M—600-volt plate supply secondaries, 4400 turns No. 34 enameled.

Coil N—200-volt grid supply, 1400 turns No. 36 enameled.

Rectifier chokes, L3: General Radio type 366.

Rectifier condenser C4: Any make of condenser that will stand the voltage. This means about 200 volts at the C-filter, and 800 volts maximum at the B-filter. The capacity of each condenser may be 3-μfd. for the B-filter and 4-μfd. for the C-filter.

Operation

In order to simplify the wiring diagram of Fig. 1 the transmitting circuit is shown separate from the rectifiers. The coil L4 in the plate circuit of the oscillator tube is a single layer coil with the turns adjusted so that the crystal operates properly without a tuning condenser across this coil, thus eliminating one control. No data can be given on this, for it will vary with different frequency quartz plates. In this particular case, with a 160-meter plate, it consists of 40 turns of No. 20 wire on a form 2-3/4" in diameter. The simplest way to get this inductance right is to put a .5 ampere meter in the tank circuit L1, C1 as shown by the arrow. Now if the coil L4 has been wound previously with what is known to be too many turns, the tank current will come up gradually as the wire is removed from L4 one turn at a time. If the proper point is passed, the tank current falls off rapidly. If too many turns are used, there is a tendency for the oscillator and amplifier circuits to oscillate of their own accord.

When the circuit up to this point is working at its best, connect it to the amplifier

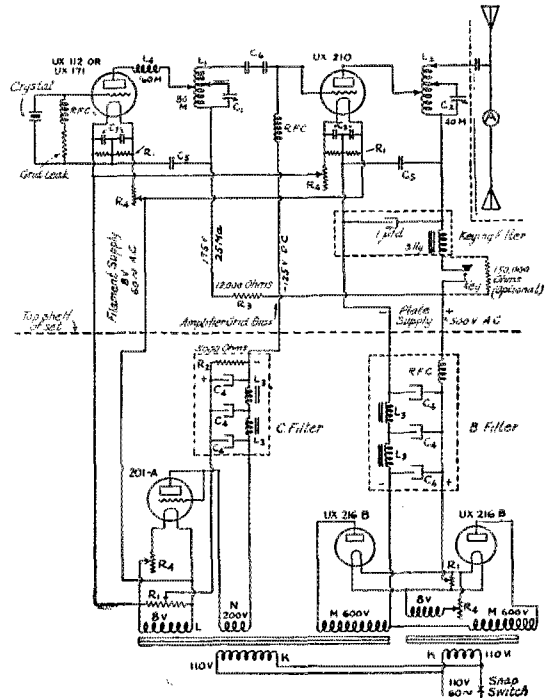

FIG. 1. THE COMPLETE WIRING DIAGRAM

The parts above the dashed cross-line are on the top shelf and comprise the transmitter proper. The parts below this line are on the lower shelf which is the power-supply unit. The constants not given in the text are—
R3—12,000-ohm lavite resistor to reduce plate voltage for oscillator.
R4—Ordinary filament rheostats, each suited to its particular tube.
C5—Stopping condensers, .01 microfarad each.
C6—Coupling condensers, Sangamo mica, .001 microfarads each.
The antenna and ground connections may be made as shown or in any one of several other ways to suit the location.

tube, retuning the 80-meter tank circuit L1, C1 to resonance. Now couple a wavemeter to the output coil L2 of the amplifier, and tune these circuits to 40 meters, slightly retuning the 80-meter tank if necessary. The wavemeter should have at least a 2-ampere meter in series.

The transmitter should now be working properly. Under these conditions, the amplifier is taking about 60 M.A., the oscillator about 25 M.A. If the quartz plate holder is touched on the grid side, or removed from circuit, the high frequency output of the amplifier drops instantly to zero, and the plate current nearly so.

It should be noted that a comparatively high value of C-voltage is being used on the amplifier. This produces a badly distorted output, but this is just what is desired for it means increase in the value of the harmonics, and greater output at 40 meters.

The value of C-voltage is adjusted by changing the 5000-ohm resistance R2.

For the sake of simplicity no meter connections have been shown in Fig. 1. The photographs show that three meters are

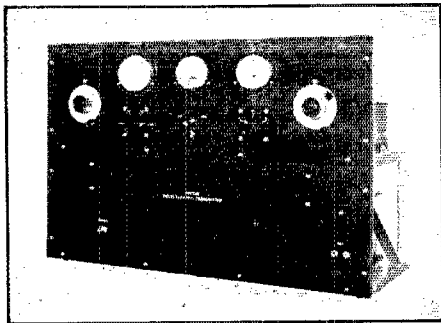

Front view of the set exhibited at the Hudson Division Convention at New York in May. Three of these sets have been built by amateurs in and near Boston.

used. Looking at the front of the set we have at the left an A.C. filament voltmeter which is connected to a pair of multigraph contact switches operated by an insulated shaft. This shaft is turned by the knob just below the meter. There are 4 switch positions so that the filament voltages may be read for the oscillator, amplifier, B-rectifier and C-rectifier. The central meter is a Weston 0-100 milliammeter connected to a Western Electric 272-A two-position switch so that it may read the plate current for either the oscillator or the amplifier. The meter at the right is a Weston 0-1 milliammeter connected in series with a 1-megohm resistance which makes the meter into a high-resistance voltmeter giving full-scale deflection at 1000 volts. The ordinary type of voltmeter is entirely unsuited to this purpose because of the relatively large current that it requires.

The holder for the quartz plate is of the standard General Radio type, having clearance above the plate, instead of the small weight often used. This makes the frequency more constant for accurate calibration work, but is of little importance for transmission. However, many pieces of quartz will not work with pressure. Various types of holders of both types have been described in previous issues of *QST*. Care should be taken to keep the plate clean, free from moisture, and even finger marks, or its operation may become erratic. If a brush discharge takes place (and it usually does,) the metal plates of the holder will soon corrode and stop oscillations, requiring frequent cleaning.

Amateurs in general may object to the low voltage being supplied the oscillator tube, but after puncturing two 200-meter plates

with 400 volts in about as many minutes, the writer concluded that a lower voltage would be more generally useful. Because of this low voltage, no C-battery is used on the oscillator grid. Its addition cuts the plate current as would be expected, but the output goes down too, so there is no advantage.

Attention should be called to the key thump filter which follows general suggestions made by Mr. Kruse in a recent edition of *QST*. Without the filter, broadcast receivers in the immediate neighborhood were seriously bothered, but its addition made reception possible 20 feet away, with an antenna nearly parallel, with no trouble whatever. The key thump is materially reduced by a 150,000-ohm resistance across the key. This gives the note a pleasing characteristic, for it leaves a very small input to the antenna with the key open.

With this type of transmitter, and a quartz plate of approximately 160 meters, it is possible to work on either 20, 40, or 80 meters, without neutralizing. For 80-meter operation, simply short the coil L4 in the oscillator plate circuit, and tune the tank circuit LC to 160 meters, and the output circuit of the amplifier (L2 C2) to 80 meters. For 20 meters, the arrangement is the same as for 40, except that the amplifier plate circuit is tuned to 20 meters.

Increased power is perfectly possible by adding more amplification after the UX-210 now used, but it will be necessary to neutralize this last stage. Tubes up to 250 watts can, and are, being excited to full output by a 210 tube.²

Acknowledgement for many helpful suggestions, particularly the oscillator plate circuit arrangement, is made by Dr E. D. Tillyer and Mr. J. M. Wells (1XAX and 1ZD) both of the American Optical Company.

² It is possible that such tubes are being operated at full output but it hardly seems likely that the UX-210 can be supplying all the energy needed to operate the grid of a 250-watt tube. The difference is probably made up by feedback in the 250-watt tube circuit which may operate as a partially neutralized R. F. stage, oscillating only when additional grid power is supplied (under crystal control to be sure) from the UX-210.—Tech. Ed.

Central New York State (Atlantic Division Convention)

THE Central New York State (Atlantic Division) Convention is to be held at Utica, N. Y., Sunday August 29th under the Auspices of the Mohawk Valley Brass Pounders. All amateurs are invited to this third annual hamfest and a good time and a good crowd is guaranteed. Write for particulars to Chas. H. Schrader, 236 Genesee Street, Utica, N. Y. Don't fail to be there!

A Grid-Meter Driver

By W. A. Hoffman*

MEASUREMENTS at radio frequencies depend largely upon some form of radio frequency generator, or driver. A glance through the new issue of Robison's *Manual of Radio Telegraphy and Telephony*, a splendid manual and authority on latest radio practices, shows that out of twenty six measurements described, sixteen require the use of a radio frequency driver.

A driver should be a persistent oscillator at all possible adjustments of the constants making up the radio frequency circuit. If energy of variable strength is to be transferred to other circuits, the variation can be brought about easily by means external to the oscillator. It should only be necessary to connect the proper A-and B-power supply to the driver unit and to make the

A driver filling these requirements, and having a range from 12 to 800 meters, has been in use for making all sorts of R.F. measurements at the C. F. Burgess Laboratories for more than a year. Recently this driver has been duplicated in a convenient

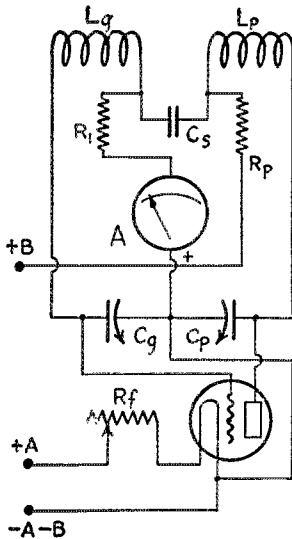

FIG. 1. THE SCHEMATIC CIRCUIT

- A 0-15 milliamper meter
- Cg-Cp Cardwell double unit condenser, 350-muif. each
- Cs Dubilier Micadon fixed condenser, 6,000-muif.
- T Tube, 199, 201-A or 210, depending on power required
- Ri Grid leak resistance, 5000 ohms
- Rf Filament rheostat
- Rp Plate supply resistance, 100 to 500 ohms
- Lg and Lp coils on common tube, 3" diameter and 4 1/2 inches long

	Wavelength range
Coil 1 2 turns each section No 16 D.C.C.	12 to 32
Coil 2 5 ditto	25 to 67
Coil 3 13 ditto	54 to 150
Coil 4 33 turns each section No 22 S.C.C.	135 to 370
Coil 5 74 ditto (bank wound)	310 to 800

required adjustment for wavelength or frequency.

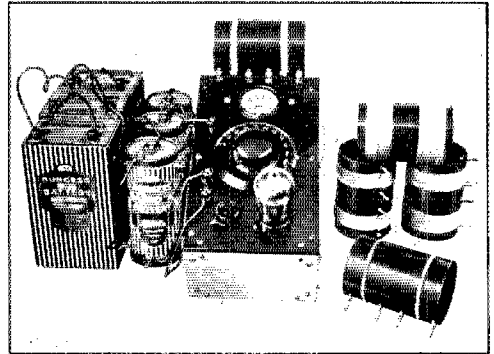

FIG. 2. OSCILLATOR AND ALL COILS

and compact form. A complete description and photographs of the latest type appears in the following paragraphs.

All the parts are mounted on the panel which is a 3/16 inch piece of bakelite 6 x 10 inches. This panel is securely secured to the top of an aluminum case built up on brass angles in the corners and round the top. The case measures 6 x 4 1/2 x 10 inches, outside dimensions. A double unit Cardwell receiving condenser is mounted in the center of the panel. A National Velvet vernier dial gives the necessary slow motion control. At one end of the panel the tube socket and filament rheostat are mounted, while at the other end there are four binding posts for receiving the driver coils, and a 0-15 Jewell milliammeter for registering the tube grid current. Five plug-in coils are wound on 3" bakelite tubing, and are equipped with General Radio 274-P plugs.

The schematic diagram shows the circuit arrangement. Capacity reaction is included between the tube elements in a manner which maintains a one to one ratio for all adjustments. The milliammeter is in series with the grid leak resistance and registers the grid current. A resistance is also provided in the A-battery supply. No R.F. chokes are required at any frequency.

The driver will operate equally well with the 199, 201-A or 210 type tube. It is only necessary to connect the proper filament and plate voltage for operation of the tube desired. The receiving tubes furnish sufficient power for most measurements, using from 45 to 135 volts of B battery. The 210 tube will furnish more power when required for

* C. F. Burgess Laboratories, Madison, Wisconsin.

such measurements as high frequency resistance. Plate voltages as high as 350 or more may be used.

The grid milliammeter is for indication of resonance between the driver and another tuned or resonant circuit. This method of resonance detection makes use

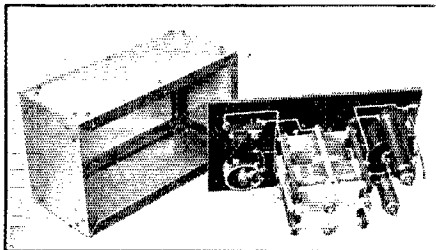

FIG. 3. INSIDE OF OSCILLATOR AND CASE

of the fact that the value of grid current in an oscillating tube circuit drops off sharply at resonance with a coupled circuit. Resonance is indicated by a pronounced dip of the milliammeter. The point of maximum deflection denotes resonance between the driver and the external circuit. The click method may also be used, if desired, by connecting a pair of telephones in series with the positive of the B-battery supply.

Some Applications

One important use for the driver, probably of interest to all amateurs, is the accurate calibration that can be obtained on a wavemeter from standard frequency transmissions. The procedure is as follows:

Tune in the standard frequency signal on a receiver in the usual manner and adjust to zero beat. Set up the driver one or two rooms away from the receiver. This will be loud and can be heard on a loud speaker. Adjust the driver to zero beat with the receiver. Next couple the wavemeter loosely to the driver and find resonance by the dip on the grid milliammeter. This setting of the wavemeter will be the setting for the standard frequency being received.

Where direct coupling cannot be made to a coil or circuit under measurement, such as is sometimes found in a cabinet of when the coil to be measured is surrounded by other apparatus, coupling may be obtained by the use of a link circuit. The link may consist of a closed loop of insulated wire having two or three turns at each end, with the intermediate portion formed into a twisted pair. The coil at one end is coupled to the driver while the coil at the other end is coupled to the circuit under measurement. The total length of the link coupling conductor should not exceed one half wavelength. Resonance will be indicated in the same manner as though direct coupling were being used.

Ohio State Convention (Central Division)

August 20-21, 1926.

THE Hotel Winton, Cleveland, Ohio, has been selected as the headquarters for this year's convention which is to be held under the auspices of the Cleveland Radio Amateur Association. The committee has made arrangements with the hotel people whereby reasonable rates will be granted delegates when several congenial fellows occupy a large room. The sessions of the convention proper will be held at Euclid Beach Park, located on Lake Erie. The Park is owned and operated by 8-APY, one of the most active and enthusiastic amateurs in the city, who will see that the park is yours during the convention. The committee in charge want to make this the best Ohio convention and have decided that Amusement is to be the key-note of this gathering of "Hams." Stork, 8-BYN, the new Section Communications Manager, will be there and will want to meet every one. Fred Schnell will be present and will have something new to show, and Headquarters will have a representative.

The closing event of the convention will be the initiation into the Royal Order of the Wouf Hong to be staged by the CRAA. Fellows, this will be your chance to join this wonderful fraternity.

The convention cost is \$5.00, and for those wishing initiation in the ROWH \$1.00 extra; in other words, \$6.00 will cover all convention activities including the Banquet.

If you are going, write N. H. Gimmy, 13503 Emily St., East Cleveland, Ohio.

Strays

Walter McCook suggests that a 500-turn honeycomb coil plugged into the simple long wave receiver described in the March 1925 issue of *QST*, in the article "Learning By Listening", will bring in both sides of the transatlantic radio telephone tests going on between the R.C.A. station 2XS and the corresponding station in England.

NOTICE

The wavemeter offer has been extended for one month. Subscriptions received by August 31st will count toward your wavemeter.

See the inside rear covers of the June and July issues of *QST*.

Another Mystery

By Rufus P. Turner*

A WEEK or so ago, in order to win a wager, I talked to a number of my neighbors (both with code and phone AND YET USED NO TRANSMITTER IN DOING SO. A trick was suspected by my friends and they thoroughly inspected my station only to find connected to the antenna a coil shunted by a condenser (variable) and a key and microphone thrown in along with the rest. My transmitter was disassembled at the time but yet they will

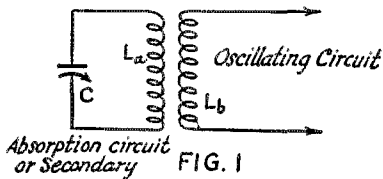

FIG. 1

not be convinced that I have not some transmitting instruments hidden about the house somewhere. None of my friends who have witnessed the mysterious transmission have been able to comprehend my explanations

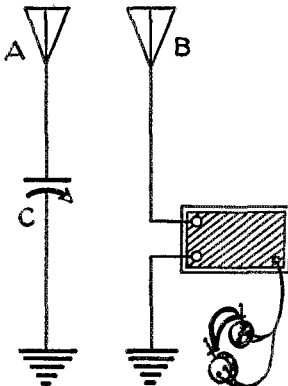

FIG. 2

but here it is—perhaps some of you operators would like to try it out in your community also. (It is hardly likely that such transmission can be carried on outside of one's neighborhood).

All of us are familiar with the so-called "absorption" circuit, having come in contact with it in using wavemeters, wavetraps, loop modulations or absorption tuning. A typical absorption circuit is shown in Fig. 1; L_a , tuned by C , comprises the absorption circuit which is inductively coupled to L_b , which may be the inductance of a receiver or transmitter. When C is adjusted and L_a tuned to the wavelength of L_b , we say that resonance is brought about and, as a result, L_a may even absorb enough energy from L_b to prevent the circuit (in which L_b is incorporated) from oscillating. When the circuit L_aC is used as a wavemeter and a small electric lamp inserted, the absorbed energy from L_b (if it happens to be the in-

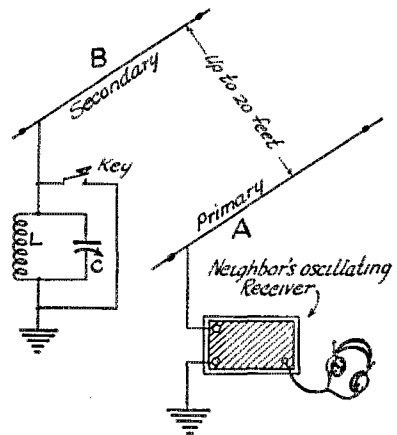

FIG. 3

ductance of a transmitter) will cause the bulb to glow brightly. The action is perfectly natural because the "absorption" circuit is simply acting as a secondary.

Similarly, antennas may absorb energy from each other when tuned to resonance. My first experiment is illustrated in Fig. 2; I erected a single wire antenna very near a neighbor's aerial and incorporated between it and the ground, a variable condenser (which was used to bring my antenna in resonance with his). Just as I surmised, when his set was oscillating, I could tune my antenna to the wavelength of his and stop the oscillation of his receiver alto-

* 3LF, 3AJF-427 Franklin St., N. W., Washington, D. C.

(Concluded on Page 64)

Convention Success

By Don C. Wallace*

It is high time to begin planning the League Convention of next winter. To help that planning there follows the story of the work that made a great A.R.R.L. meeting—work that began almost a year ahead of time.— Editor.

TEN months ahead of time, in January, it was decided to hold the Dakota Division Convention in Thanksgiving week, inasmuch as interest in radio would then be high and a traveling day would be available before and after the two days on which the convention was to be held.

The Dakota Division is an unusually large Division in point of territory, and it was realized that considerable incentive must be offered, in order that men residing in the Dakotas and in the extremes of Minnesota would come to the Twin Cities. About this time, Professor Jansky, A. R. R. L. Director for the Division, suggested that the Convention could very well be held at the University of Minnesota. Authorization of Division Manager Jensen was secured to hold the convention under the auspices of a committee functioning under the writer who was Assistant Division Manager. About this time, Jensen resigned as Division Manager, and the writer was elected, thereby centering the responsibility of the convention more than ever.

In the meantime, various men had been approached as to their willingness to cooperate in putting the Convention over. Chief among these was the chairman of the Publicity Committee, H. D. Jones, 9GD. He immediately started his work, and put out an effective card *early in the summer (several months before the Convention)*, stating that the Convention would be held. This card was forwarded to a mailing list made up from all of the A.R.R.L. members in the state, a great many of those who had licenses and yet were not members of the A. R. R. L., and a general addition to the list as suggested by members at meetings of the Twin City Radio Club.

Along in the late spring, several of the committee chairmen were appointed. The chief committees were functioning very nicely *five months previous to the Convention*, and Professor Jansky, 9XI, chairman of the Program Committee was arranging for speakers. About this time, W. C. Hilgedick, 9GZ, was gathering information for the Wouff-Hong initiation, and the Finance Committee was attempting to raise some additional money in order to start things out with a bang.

We early realized that the Finance Committee was one of the most important committees we had, but we could not raise any definite sum about the Twin Cities. It then occurred to the writer that it might be a good thing to prepare a Division manual, covering all of the proposed activities of the Convention. Immediately, a thirty-six page booklet was edited, and by lively use of the telephone, advertising space was sold in this Manual at the rate of \$50.00 per page. In about one and one-half or two hours, \$400.00 had been raised in this manner from which the printing expense of \$148.00 was to be deducted. This Manual has since proven to be one of the valuable assets of the Division, inasmuch as it carries a list of all of the ORS, (over one hundred in number), a list of the Division officers (twenty-one) a list of all the committees who helped put the Convention over,—besides being a complete Manual on the Convention program, menu, and a list of active stations in the Twin Cities who opened their stations to the visiting delegates.

One of the chief ads obtained was a \$100.00 ad from the Gold Medal Company. Strange as it may seem, they devoted their entire two pages in thanking the ARRL for their activities, and extended them an invitation to visit station WCCO in their Executive Offices at the Oak Grove Hotel.

Towards the end of summer, the chairmen of the committees got together for luncheon every Monday noon at the Men's Union (a club) on the campus of the University of Minnesota. Usually from eight to fifteen were present at these weekly luncheons, where plans for a good, high-class, snappy Convention rapidly materialized.

About this time, 800 letters were mailed out. There are only about 450 or 500 A.R.R.L. members in the entire Dakota Division. When it is considered that we had 188 registrations at \$4.00 apiece, the remarkable way in which the Publicity Committee covered the field, can be shown. One month before the Convention, 100 letters were sent out to all ORS's, telling them to broadcast from then until the time of the Convention, the following:

"MEET DON MIX AT THE DAKOTA DIVISION CONVENTION, NOVEMBER 28TH AND 29TH, MINNEAPOLIS."

Along in September, the Twin City Radio

* 9ZT-9XAX, Former Manager Dakota Division A.R.R.L.

Club was re-organized and put on a firm footing, partly to create a stronger organization but somewhat in order that bi-weekly mass meetings could be held to "enthuse" the Twin City crowd. The Division Manager was allowed the first half hour of each of these meetings for anything he desired, and needless to say, these bi-weekly mass meetings, which were attended by 75 or 100 men, did a great deal to put over the idea to the Twin City men. The men who attended these bi-weekly meetings would offer suggestions, and if they seemed reasonable, they would go forth *immediately*.

Prizes

Four months prior to the time of the Convention, circulars were sent to all advertisers of QST for prizes, and approximately \$500.00 worth came in as a result. In securing these prizes, it was stated that they would be given full credit in the Dakota Division Manual for having donated these prizes, and that each man who won a prize would write them an acknowledgement, thanking them for the prize as he received it. We also stated that before a meeting of the Convention, a complete list would be read. Needless to say, all of these promises have been fulfilled.

Tours

It was early seen that the sight-seeing tour and contests were going to take quite a bit of time. These were accordingly placed on the same afternoon, so that those who wanted to sight-see more could miss some of the contests, and those who wanted to participate in all of the contests would have ample time. The tour included amateur, broadcast and military radio stations, also a wired wireless installation.

The "Drawing Card"

Fully six months ago, it was realized that a real drawing card would be necessary in order to really put over a successful Convention. Out of two or three possibilities, Don Mix was selected, and radiograms were broadcast to him at frequent intervals while he was still frozen in at Etah. He never received these but they had a telling effect upon the spirit of the Division, and when he finally returned, letters and telegrams were waiting, so that he would be sure to come, at the Convention's expense.

The Banquet

Don Mix also proved a drawing card at the Banquet which was held at the wonderful new Nicollet hotel just recently completed in Minneapolis. Eight hundred tickets were printed, to sell at \$2.50 each for this Banquet, and were divided among the different people throughout the city in lots of five and ten, so that everybody would have an opportunity of buying or selling them. Serial numbers were used, so as to

simplify the checking in of these tickets. This gave us a resultant number at the Banquet of over 250.

One of the musical members of the A.R.R.L. organized a Ham Orchestra which lent suitable atmosphere to the Banquet, and assured us that the orchestra would not feel bad if terrific whistling of code signals should at any time drown out the music.

The Division Manager remembered having attended the National Convention of Chicago, where throughout the entire meeting, someone was always saying, "Please do not blow your whistle." To overcome this difficulty, about 300 whistles were purchased and used as favors at each plate at the Banquet. Because *every one* had a whistle and *could* blow it to his heart's content, there wasn't one single break in the program, due to undue whistling. There was whistling at the right time, and absolute quietness otherwise.

The Program Committee, working in conjunction with the Division Manager, was very fortunate in securing unusually appropriate speakers for the entire Convention. Too many speakers were not secured, and so every meeting went off in a snappy manner, and *exactly according to schedule*.

Summary

When we look back on the whole situation, we certainly feel pleased with our Division, and realize that the causes for success boiled down to these things.

1. The sale of advertising in the Manual gave us plenty of money.
2. Weekly meetings for four months previous to the time of the Convention by the chairmen of the committees.
3. Bi-weekly meetings of the Twin City Radio Club, which were advertised as "Radio Mass Meetings."
4. Plenty of newspaper publicity. Every Sunday, for five or six Sundays, feature stories were carried in the Minneapolis Tribune, and during the week of the Convention, at least a half-column story appeared in every day's issue, illustrated with pictures of at least one of the speakers.
5. Too much cannot be said in favor of the plan of getting some one and paying his expenses,—some one who's name is a real drawing card. It does not matter whether he can speak or not, although we were fortunate in securing Don Mix, who brought one hundred twenty-five slides and *did* talk well.
6. In addition, if co-operation from Headquarters is secured, as was here, the Convention is sure to be a great success.
7. The interest of the BCL's in putting the A.R.R.L. on the map was considered at all times. One and one-quarter hours of the main part of the Banquet was broadcast

(Concluded on Page 64)

Experimenters' Section Report

OUTLINES are proceeding—as usual. The majority of members now hold outlines on all the problems on which they have worked or are enrolled for. Those who have not received their outlines are asked to send for them, addressing Experimenters' Section, American Radio Relay League, Hartford, Conn.

Enrollment

We have been asked to mention the conditions of membership in this section more in detail. There are no details, one simply asks for the blanks, checks off the problems of interest, sends in the blank and the thing is done. Outlines and test schedules, also a classified list of other members will then be sent. There are no obligations.

International 5 Meter Tests

Recent tests have lent encouragement to the more active following of 5-meter work. It has now been decided that there will be run a month of observations and tests as follows.

Thursday of each week in August there will be transmission from U.S. stations 2EB, 2NZ, 9ZT, 2AUZ and 10A. All others are urged to *send as well as listen*. Automatic keying is best as it is easier to keep schedules. The schedule is as follows:

Eastern Standard Time	London Time	G. M. T.
6 A. M.	11 A. M.	11
1 P. M.	6 P. M.	18
7 P. M.	12 Midnight	24

(end of Thursday)

Each schedule is to last $\frac{1}{2}$ hour. The same schedules are to be used on Sundays for attempts at two-way communication between any two stations in any country or countries. Since there *may* be a long skip distance it is well to try schedules at very long distances, 10,000 miles or so. However the writer is not at all sure that there is really so long a skip at all times, in view of the work of 8SM (French) and 2EB (American).

Sending Sets

In this work the "5 watter" will not mean very much, the output is too small for the rather poor tuners that most of us will be compelled to use—because we do not know enough to build good ones.

The 250-watt tube can be gotten down to 4 and 5 meters easily. One just connects the grid and plate via a small variable condenser. A leak in series with a choke goes

from filament to grid and the plate is fed through an R.F. choke.

The DeForest H tube is best of all. This beautiful little tube gets down to 1 meter with comparative ease using the circuit mentioned above (which was shown in last month's QST) and it will also operate perfectly in the Mesny-Vallauri circuit or in the peculiar "series" circuit shown in the article just mentioned. The secret of H tube operation is to use a HIGH RESISTANCE grid leak. This does not mean a mere 10,000 ohms—the correct value is between 48,000 and 75,000 ohms depending on the conditions of operation. At least 700 volts should be used on the plate and 1500 is better.

Important Note

Please keep a complete log and send it to the Experimenters' Section. By all means include diagrams, dimensions and any interesting experiences. This sort of material loses 90% of its value unless it is centralized and the X Section is willing to act as the center.

A Reflexed Oscillator

By H. P. Westman

Information Service, A.R.R.L.

THERE are quite a few cases where it is desirable to use an oscillator in checking the wavelength range of a set employing a non-oscillating detector. The usual method has been to use a buzzer-

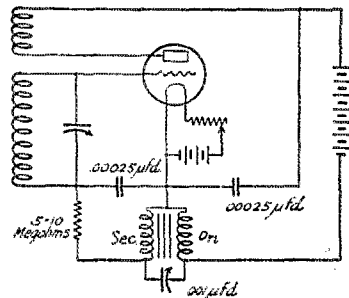

excited wavemeter for such measurements. Its big drawback is the broadness of tuning and the fact that when the wavemeter is located close to the operator and the set under test is not very sensitive, it becomes

hard to distinguish just what proportion of the signal is heard through the phones and how much is heard directly from the buzzer. Then, of course, there is the usual trouble in keeping the buzzer from sticking and fussing, particularly if the measurements take a considerable length of time.

The most practical way of obtaining a sharp wave is to use a tube oscillator. The radio frequency output of such a circuit may be modulated by an audio frequency which has also been generated by a tube. Under such conditions this will be a duplicate of the buzzer-excited wavemeter.

Such an arrangement will give a sharp radio frequency wave modulated by a constant audio frequency and provided the battery supply to the equipment does not vary there should be no change in either of the frequencies over long periods of time.

It is not necessary to use two tubes for the generation of these frequencies, as one tube can be reflexed to allow it to do the work of two. Unlike most reflexes, it is not so tricky as to render it impractical to be set up in a hurry and used without spending the time ordinarily required for two experiments to get it going properly.

The radio frequency circuit is the tickler feedback one used in receiving sets. Its constants will vary with the wavelength on which the set is to be operated. If it is to be used in the amateur bands, plug-in-coils may be used advantageously. For the broadcast waves, a vario-coupler would be helpful. One good use for it on this band is in the neutralizing of neutrodyne receivers.

It can be used for the matching of superhet transformers and will then have to tune up to the wave on which these transformers are designed to operate. The inductances may be honeycomb coils for this range.

The audio frequency portion of the circuit consists of a regulation audio frequency transformer with the primary winding in the plate circuit and the secondary winding in the grid circuit. Both of these windings are shunted with by-pass condensers to offer a low impedance to the radio frequency energy. Do not make these any larger than necessary as they also lower the frequency to which the audio circuit tunes.

A grid leak of from .5 to 10 megohms is connected in series with the secondary to cause a drop in the voltage applied to the grid as without this the audio frequency currents are so strong as to make the radio frequency circuit action very irregular.

A .001 μ fd. variable condenser may be connected across the high ends of the transformer to vary the note and in the particular transformer used gave a consid-

erable range. Any transformer may be used and any type of coil winding employed which will work properly in an ordinary circuit.

Some Beautiful Transmission Tests

The January issue of the Bell System Technical Journal describes some unique tests on selective fading. The work is done and the account is written with that splendid perfection and completeness which we have learned to associate with the work of this Laboratory. No man with the least interest in transmission should overlook these tests.

A "Static Shooting" Radio Compass

The difficulty of finding the direction from which static comes is that frequently the stuff consists mainly of isolated crashes that one cannot "swing a loop on." At other times there may be grinders from one direction with crashes from another. To get around this difficulty Messrs. J. F. Herd and R. A. Watson have devised a unique radio compass which is described in the *Wireless World and Radio Review* (London) for March 10, 1926.

The scheme is to connect a pair of crossed loops to a Braun tube (cathode ray oscillograph) in such a fashion that a splash of static will make a momentary straight line of light whose direction will indicate the direction from which the static arrived—or rather the "line of direction" of its travel.

Two crossed loops are used, each one being specially connected as shown in the diagram so as to balance out the antenna effect and leave only true loop effect. The N-S loop connects to one pair of deflection plates on a Western Electric Braun tube, therefore if a splash of energy is received by this loop alone the glowing dot on the plate of the tube will momentarily lengthen out into a line. If the tube is set with the large end up and properly oriented this line can be made to run N-S on the screen of the tube. The E-W loop is connected to the other pair of deflection plates and therefore causes the spot to deflect in the other (right angle) direction. If the energy arrives at an angle to both loops the spot will take an excursion along a line in that same direction.

The eye is a pretty mechanism and observes such matters very promptly, therefore the scheme is a practical compass for momentary impulses. Of course it can also be used for signals that "stay put."

(Concluded on Page 64)

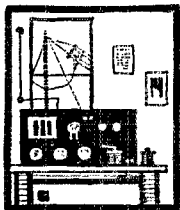

Amateur Radio Stations



2AHM, Schenectady, N. Y.

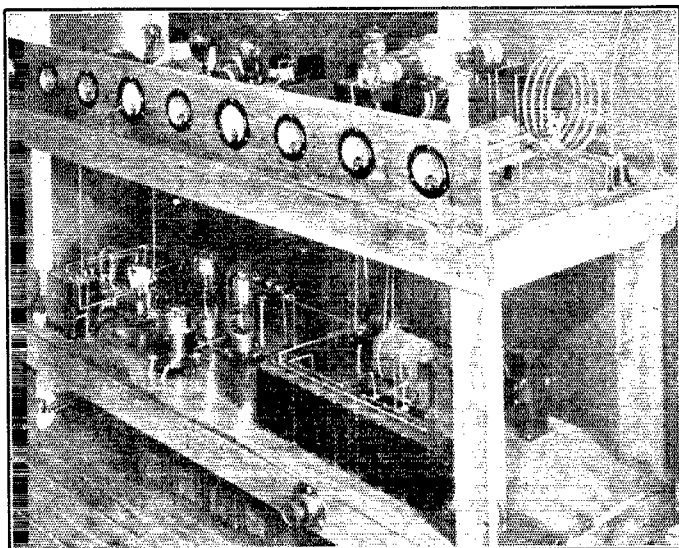

2AHM is the crystal-controlled station owned and operated by W. E. Jackson, 130 Mill Street, Schenectady, N. Y. The operator is none other than the universally known 1CMP. (Note—1CMP is operated by Mr. Jackson's brother at present).

The quartz crystal has a fundamental of 318 meters. The set is arranged to work on either 39.75 or 19.875 meters. The shorter wave is obtained by picking up the eighth or sixteenth harmonic of the crystal and amplifying, or some other order of harmonic giving the same final wavelength. Several arrangements were tried but the scheme which proved most successful was the idea of working on second harmonic throughout all stages except the last one. The last stage is a 204-A amplifying at the frequency of the preceding stage. This scheme of using second harmonics obviates the necessity of neutralizing each of the stages. To prevent self-oscillation the last

stage which operates at the frequency it amplifies, is neutralized by one half of the coil L7 and the condenser C19 shown in the circuit layout.

Crystals vary greatly in their quality as oscillators. A good crystal needs no regeneration outside that already provided through the tube capacity. The crystal at 2AHM is a lame one, but has been made to work quite satisfactorily by inserting the coil L1. To reduce the plate voltage from 500 to 400 for the crystal tube the resistance R1 is used. The resistance R2 is used on the 203-A tube, reducing the plate voltage to 1,000.

As will be seen from the photograph the complete transmitter is mounted on a table. The top shelf contains all of the high frequency equipment which extends from left to right as in the circuit diagram. The bottom shelf houses the plate and filament supply for the tubes. For the UX210

crystal tube and the three UX210 power amplifiers, plate supply comes from a 200-watt 500-volt transformer, rectification being done through two 216-B tubes. A brute force filter consisting of a 30-henry choke and a 12-microfarad condenser effectively smoothes the supply. Power supply for the large tubes is obtained from an Acme 600-watt 1,500-volt transformer. The high voltage is rectified by two UV217-A's and filtered by another brute force filter. The biasing voltage, used to distort the wave

and swing condenser C18 back and forth through its entire range and at the same time adjust C19 until no deviation in either plate current of the 203-A or grid current in the 204-A occurs. After the last stage has been so neutralized, tune the tank circuit to 39.75 meters as has been previously done.

To tune the set to 19.75 meters the following changes are made: First, reverse S1 and close S2 and place the UX210 in the fourth stage. Retune C15 for minimum

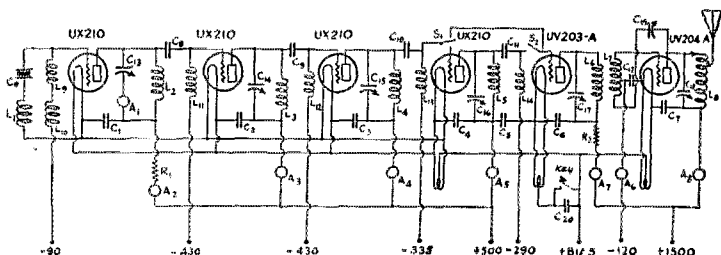

CRYSTAL-CONTROL SET AT 2AHM

CO Crystal and holder

The following inductances are wound on a 3" tube, coils tapped at their centers:

- L1 78 turns No. 20 D.C.C.
 - L2 34 turns No. 20 D.C.C.
 - L3 32 turns No. 20 D.C.C.
 - L4 11 turns No. 20 D.C.C.
 - L5 5 turns No. 20 D.C.C.
 - L6 5 turns No. 18 D.C.C.
 - L7 9 turns No. 18 D.C.C.
 - L8 4 turns of R.C.A. helix, turns spaced $\frac{3}{8}$ inch with Pyrex tubing.
 - L9-L10 240 turns No. 36 D.S.C. on $2\frac{1}{4}$ inch tube
 - L11 160 turns No. 36 D.S.C. on 3 inch tube.
 - L12 ditto
 - L13 110 turns No. 28 D.S.C. on $2\frac{1}{2}$ inch tube.
 - L14 35 turns ditto.
- The following condensers are 2,000- μ fd. mica type:

- C1, C2, C3, C4, C6, C7. And these are 500- μ fd. each.
- C5, C8, C9, C10, C11, C12, and C20.
- C13 500- μ fd. G. R. Variable receiving condenser.
- C14 70- μ fd. ditto.
- C15 110- μ fd. ditto.
- C16 50- μ fd. ditto.
- C17 110- μ fd. ditto.
- C18 Ditto
- C19 45- μ fd. variable neutralizing condenser.
- R1 5,000 ohms.
- R2 4,000 ohms.
- A1 0-500 M.A. Weston thermocouple meter.
- A2 0-100 D.C. milliammeter
- A3-A4-A5 0-300 D.C. milliammeter.
- A6 0-200 D.C. milliammeter.
- A7 0-300 D.C. milliammeter.
- A8 0-500 D.C. milliammeter.

form so that the second harmonics will be more pronounced, is obtained from the flock of Burgess B's under the table.

When placing the set in operation, the following procedure is followed: The tank circuit of the crystal tube is first tuned to 318 meters. Resonance will be indicated by a maximum deflection of the meter A1. The tank circuit of the first stage (the second tube) is tuned to the second harmonic of the crystal (159 meters), resonance being indicated by the minimum deflection of milliammeter A3. In like manner the third tube is tuned to the second harmonic of the second tube (79.5 meters) resonance being indicated as previously mentioned. Next, leaving the switches S1 and S2 as shown in the diagram and removing the fourth UX210 from its socket, the tank circuit of the 203-A is tuned to 39.75 meters. Resonance will be indicated by a minimum deflection of the meter A7. Lastly the 204-A stage is neutralized. Cut off the power to the 204-A

plate current, tuning the circuit to 79.5 meters. This retuning is necessary because the grid filament capacity of the 210 is less than that of the 203-A. Now tune the tank of the fourth tube to 39.75 meters. The coil L6 is replaced by one of similar dimensions having only two turns and L7 is replaced by a coil having four turns tapped in the center. The coil ends and center tap are terminated on General Radio plugs which are mounted on a bakelite strip fastened to the side of the tubing. These five plugs are made to fit five jacks which are permanently connected into the circuit.

The tank circuit of the 203-A is tuned to 20 meters and the 204-A stage neutralized as before. Coil L8 is changed to have one and a half turns and lastly the 204-A is tuned to 20 meters.

The keying at 2AHM is unique in that no key clicks result. The d.c. grid and d.c. plate circuits of the 203-A stage are broken simultaneously. This, in turn, removes the

excitation from the 204-A which is so biased that it cuts off entirely when the excitation is removed.

The antenna is a horizontal wire 120 feet long and 25 feet high. At 39.75 meters the antenna is working at the second harmonic and at 19.875 meters is working at the fourth harmonic.

Although the set is more or less an experimental layout (so 2AHM says) it has proven

very stable and entirely foolproof. All six continents have been worked with ease and consistency on many occasions.

(Note—although the circuit would indicate that 2AHM is operated directly coupled to the antenna, Jackson is using the voltage feeder system and the circuit is not directly coupled.—Asst. Techn. Ed.)

1 AXA, Plymouth, Mass.

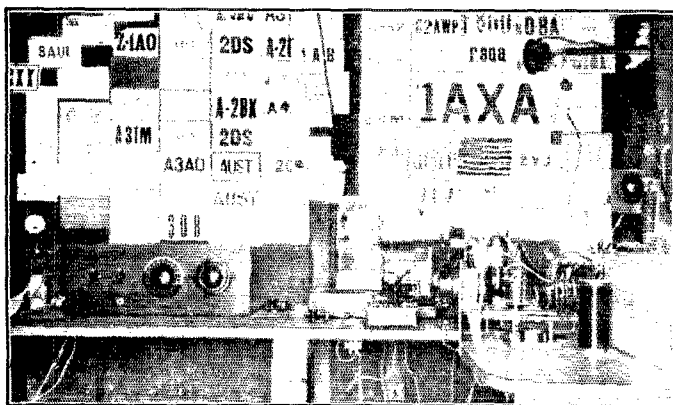

THIS is another station recently converted to crystal-control. It is the product of E. E. Pierce of 1B South Spooner Street. 1AXA has been in operation since 1924, and has been crystal-controlled for about four months.

The crystal oscillator is a UX210 tube, feeding a combined frequency doubler and power amplifier consisting of a single 203-A tube. The crystal has a fundamental of 77.2 meters. The crystal mounting consists of two brass plates accurately ground. One plate is one half inch thick and the other, the upper one, is one quarter of an inch thick. The top plate rests upon the crystal and serves as all of the pressure required for good output. Flexible leads are soldered to both plates. The oscillator inductance is an eight turn coil of copper tubing shunted by a 250- μ fd. variable condenser. A 22,000-ohm resistance is connected in series with the positive lead from the 1,000-volt transformer-rectifier unit, supplying 300 volts to the UX210. The grid bias battery on the crystal comes from a 45-volt block of B battery. With this plate voltage and this bias the normal operating plate current on the oscillator tube is 40 milliamperes.

The amplifier tube is coupled to the oscillator through a 2,000- μ fd. condenser. The plate coil of the amplifier consists of 10 turns of copper tubing five inches in diameter. A 500- μ fd. variable condenser is shunted across all of the plate coil. Coupling to the antenna is through an edge-wise wound copper coil four inches in diameter. An antenna series condenser of 250- μ fd. capacity allows the set to be operated slightly below the fundamental.

The power supply for the plates is obtained from a high voltage transformer and a thirty six jar chemical rectifier. The filter is a six henry choke and seven microfarads of condenser.

The receiver is a conventional three circuit tuner and one stage of audio frequency amplification. The receiving antenna is a single wire thirty five feet long and eight feet high. The transmitting antenna is a cage affair twenty inches in diameter and fifty feet long. The lead-in is also a four wire cage six inches in diameter and sixty feet long. The counterpoise is a single thirty foot wire eight feet high.

With an input to the amplifier of 135

(Concluded on Page 64)

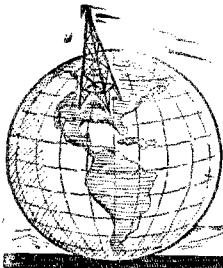

I.A.R.U. NEWS

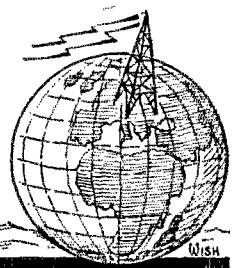

Canadian Wavelengths

From time to time we hope to publish data on the wavelengths regularly used by amateurs in all parts of the globe, together with information on the best time of the day to listen for these stations, the best wavelength to work them on, etc. We are starting off this month with our next-door neighbors, the Canadian boys.

For the fiscal year of 1926-1927 Canadian amateur experimental stations have been licensed to use the following wavelengths:

Wavelength (meters)	Frequency (kilocycles)
Pure c. w.	
0.7496— 0.7477	400,000—401,000
5.35 — 4.96	56,000— 64,000
21.4 — 18.7	14,000— 16,000
37.5 — 42.8	7,000— 8,000
*52.6 — 52.51	5,700— 5,710
85.7 — 75.0	3,500— 4,000
197.2 —150.0	1,520— 2,000
I. C. W. & Telephone	
180.0 —170.0	1,706— 1,667

*This band for British Empire work exclusively.

U. S. and European work is generally done in the 37.5—42.8-meter band. Quite a few British contacts are now had in the 52-meter band. Most of the Canadian U. S. traffic goes on in the U. S. 40-meter band, working with Canada in their 40-meter band. Exclusive Canadian traffic is usually handled in their 52-meter band.

British Section

"Very few reports have been received from British amateurs, concerning DX work, and conditions do not seem to have been very favorable during the past month. A few British stations have been allotted the special wave band of 32-34 meters by the Post Office authorities for special DX experimental work, and a watch should be kept on this waveband for these stations. As far as is known at present the following stations can be heard on this band: g2LZ, g2NM, g2OD, g2SZ. We understand that the Australians have now been allotted a band from 32 to 37 meters. To avoid local QRM the G's would appreciate it greatly if the A's would keep off of the 32-34 band when DX conditions are favorable. (Note—

we have just received a radiogram from a2YI stating that the Australian amateurs have been asked to limit operations in the 32-37-meter band to 34-37 meters—Asst. Tech. Ed.) g2SZ is now operating his crystal-controlled transmitter on 32 meters, using the third harmonic of the crystal oscillator. Considerable success has also been experienced with phone work at this station. g2LZ has been off the air during the past month but is now working daily between 0500 and 0700 G. M. T. on about 33 meters. These hours will be maintained all summer. g2OD is now on 32.1 meters with a new master-oscillator power-amplifier transmitter using 95 watts daily between 0500 and 0700 G. M. T."—E. J. Simmonds, Pres. British Section.

The T & R Section

All members of the A. R. R. L. are cordially invited to become members of the Transmitter and Relay Section of the Radio Society of Great Britain. Full particulars can be obtained from C. A. Jamblin, 82 York Road, Bury St. Edmunds, Suffolk, England. Suffice to say here that the 15/ per year dues include a subscription to the *T & R. Bulletin* published monthly. The *Bulletin* is the *QST* of the British Isles, a very worthy little magazine and one we read with interest here at *QST*. The *Bulletin* contains an account of the English activities, technical articles of much merit and interest and timely articles of interest to all amateurs in any part of the world. It is with pleasure we recommend both the T & R Section Membership, and the *Bulletin* to all A.R.R.L. members.

Ireland

W. R. Burne, formerly of the well-known station g2KW is now the Managing Editor of the *Irish Radio Journal*. Burne has been licensed to operate the experimental station of the *Journal*, the call letters being gw15B. Transmissions are going on regularly on a wavelength of 45 meters. Other waves of 8, 23 and 90 meters will be available shortly. Burne offers to forward QSL cards to Irish stations if the cards are address to Radio Station, c/o *Irish Radio Journal*, 34 Dame Street, Dublin, Ireland.

Australia

Via radio through u9CCS we have received the following news from a2YI: "During the last two months DX conditions in Australia have not been nearly as good as in the preceding months. QRN has been troublesome and the general strength of reception of American stations has not been good. Many stations who were coming in with great signal strength at this time of the year have fallen off to a point at which they are copied with difficulty, although those who are filtering their plate supply efficiently are still coming through as well as ever. Some stations using UX210 tubes are putting over remarkably fine signals, and Australian stations with this type of tube are having great success. We have just passed through our trans-Pacific test period and all Australians who took part are looking forward to something more of this nature. The tests were *real* tests of reception and transmission as the conditions were really trying. Our fellows are enthusiastic over the splendid spirit shown by the American hams taking part. Our early afternoon DX is improving with the winter months. The English and Continental stations now come through as early as three p. m., a star performer being f8JN although we are not connecting with them easily yet. South American stations are few and far between. At times we are QSO ch2LD. We are sure that the eastern South Americans would be rewarded by getting up a few mornings and trying for Australian DX. Two stations are experimenting with crystal control. a5BG has a set working on 35.5 meters and a6AG is working on his xtal transmitter now." And from a2LM via u8GZ comes a message stating that on June 18 and 19 a2LM worked g2OD while the latter was using an indoor Hertz antenna for transmission and reception. 2OD's signals were reported R6 in Australia!

Turkey

A new station and a new country! On June 6th c4DW reports hearing tFEA calling CQ on 33 meters. On June 7th u3RF reports hearing tFEA working some American station whose call he did not get and on June 9th u4SI-4TN reports working tFEA whose QRA was given as F. E. Anussieh, c/o Turkish Scientific Research Department, Constantinople, Turkey. And on June 20th u8DON worked him again. F. B. OM's. It is understood that tFEA is using a power of 600 watts and tube rectification. The wavelength is about 33 meters.

France

From f8DQ we learn of the following French activities: "QSO between North and South Africa was recently established

when fm8MB was in touch with oA6N. The amateurs of North Africa have adopted the intermediate "fm" for Morocco and "fa" for Algeria. Stations fm8MA and fm8MB are now licensed. A number of French amateurs have changed their wavelengths from 43 to 33 meters, with marked improvement in DX. On 33 meters f8CP has been QSO a number of times with u's, bz's, a's, etc., with only 14 watts input. f8JN has been doing fine DX, having worked daily with z2AC for six months; with oA6N during two months and with bz1AC for a month and a half, as well as being QSO the world over. He is the loudest European in Australia, Brazil and South Africa. f8YNB has been QSO u2AER when using an input of 2 watts. On 20 meters the first French-Brazilian contact was made by f8GI and bz1AF. Our best receiving station, f8FJ, will soon be on the air again with a new, ultra-sensitive receiver."

British Guiana

From u2CVJ we learn that Joseph T. Tasker of 61 Hadfield Street, Georgetown, British Guiana, is leaving shortly for a six months trip into the wilds of British Guiana. He is taking along a 20-watt short-wave transmitter and will be pleased to make as many amateur QSO's as possible. All QSL's of communications with him should be addressed to the above. His call will be 1JT with the intermediate "bg."

Chile

"The general conditions in Chile are always very good. Almost always the signals of the U. S. amateurs are very QSA here. On a number of occasions the small transmitters of the u's are heard quite well. In Chile there are two bands of waves which are licensed to amateurs. For telephone work one band is from 150 to 230 meters. For short wave telegraph work the band is from 34 to 37 meters. We have about twelve stations on the air in the 34-37-meter band. All except three, are using low power, either 5 watters or receiving tubes operated from the direct current city lighting mains. ch2AR is a good DXer and is operating regularly. ch2AH is a new comer. ch2AK is the best experimental station in Chile. ch3IJ has done a lot of communication work with the U. S. amateurs. ch2LD is still doing excellent DX and is the most consistent station in Chile. He is on the air regularly. He was the first Chilean to QSO five continents, with only two five watt tubes."—L. Desmares.

Indo China

We are pleased to be able to present herewith two views of station f8QQ and its operator, Richard Jamas of Saigon, French Indo China. This well-known station uses the Mesny circuit for transmission. The

present transmitter (shown in the photographs) uses two 150-watt French tubes. Power is obtained from a d. c. generator giving 2,000 volts at 800 watts for plate

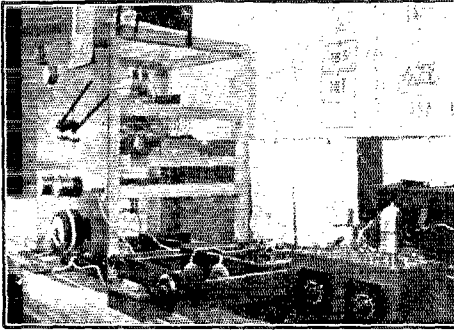

fi8QQ-8JL, SAIGON, INDO CHINA

supply and 12 volts at 200 watts for filaments. fi8QQ (now also fi8JL) operates regularly on 34.5 meters. For transmission a Hertz antenna 250 feet long and 45 feet high is used and for reception the aerial is a single wire 100 feet long and 30 feet high. The receiver is a three circuit affair using detector and one stage of audio frequency amplification. The receiver itself is mounted in a light wooden frame which rests on soft sponge rubber supports.

Plug-in coils of the narrow basket-weave type are used. In spite of very bad atmospheric conditions fi8QQ-8JL has been in

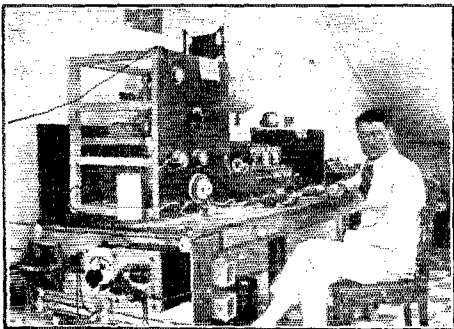

RICHARD JAMAS. THE OWNER AND OPERATOR AT fi8QQ-8JL

regular communication with France, England, South Africa, Australia, New Zealand and part of the U. S. z2AC is the best relay to France when QRN is too bad for direct contact.

Italy

In the I. A. R. U. News section for February of 1926 we announced the Italian Trans-

mission Contest. This contest has come to a close and the following results are announced by Ernesto Montu, secretary of the Radio Club of Italy.

"Long distance communication. All contestants reached New Zealand, in the following order: 1NO, 1AS, 1AY, 1RM, 1GW, 1MA and 1BD. Greatest number of two-way contacts over 5,000 kilometers; first 1NO with 236; second 1AS and third 1GW. Best work accomplished, first 1NO and 1AS, second 1GW, third 1RM. Total, first and Italian Champion 1NO; second 1AS; third, 1GW. The winner, Mr. Marietti of Turin received a gold medal and a short-wave wave meter. Dr. Pozzi of 1AS received a silver medal and a transmitting tube offered by Telefunken. All others received bronze medals and several prizes offered by local firms. The contestants very heartily thank all hams from all parts of the world for the wonderful co-operation given this con-



CONTESTANTS IN THE ITALIAN AMATEUR CONTEST

From left to right—1CO, 1GW, 1BD, 1NO the winner for 1925, Ernesto Montu organizer of the Contest, 1AS, and three members of the Italian Radio Club.

test. They hope that the same spirit of co-operation will be shown in the 1926 contest which is in progress."

Japan

From j1KK via u6DCQ we have received the following: "We have the honor of informing you that we amateurs in Japan have organized today the Japanese Amateur Radio League. Please QST to all stations" (signed) K. Kusama, j1KK, Mikagecho, Japan. This message was also forwarded to us via 6CGC, 8BRC and 1MC. Via pi1HR-u6BQ we received another message informing the amateurs of the world that the Japanese Radio Relay League has been formed, although transmission is not allowed in Japan. A similar message arrived again via 6CGC and 8BRC. u6BQ reports having worked a number of Japanese stations recently. Among others are j1TS, j1SS, j1TM, j3AA, j1ZQ, jASM, j1SK and

j1KK. So it appears that amateur radio is an actual fact in that country.—F. B.

China

Through u6HM we have received QRA's of several stations operating in China. The first contact between the U. S. and fc8EM of Shanghai was effected by 6HM. We are presenting a photo of fc8EM herewith. His QRA is Edouard Foucret, 544 Sicca-



fc8EM, EDOUARD FOUCRET, of SHANGHAI, CHINA

wei Road, Shanghai. At the time of his original U. S. contact he was using two 5-watt "Royce" tubes in a Mesny circuit, with 240 volts of dry cell B-battery. Since that time the small tubes have been replaced by two 30 watters, operating normally with an input of 100 watts. His DX has improved and he has worked as far into the U. S. as the 8th district. He is operating almost every night around 6 to 8 A. M. P. S. T. Then there is fc8FLO, Jules Michelet, Officer Radio Croiseur Francias, Shanghai, first worked by u6DAG, and fc8GG, George Galletti, 618 Avenue Joffre, Shanghai. He is using the Mesny circuit, also, and has been working a number of 6's on an indoor antenna. Also fc8XX, fc8AG, fc 2EGO and fc8ZW are all in China and can be heard between 34 and 38 meters.

The WAC Club

The WAC Club continues to expand. Here is a line-up of the membership to date: u6OI, u6HM, u1AAO, c4GT, pr4SA, u9ZT-9XAX, b4YZ, u9DNG, pi3AA, u2APV, pi1AU, u5ACL, u5JF, gi5NJ, u1CH and g2IT. Your certificate is waiting, OM. See previous I. A. R. U. News Sections of QST for further particulars. Before long there will not be a civilized country in the world that does not have its WAC Club member.

A Sub-Panel Dial

HERETOFORE, the "behind-the-panel" type of dial has appeared only in commercially manufactured sets. In home construction it is very difficult to mount any of the existing dials behind the panel, due to the fact that the scale graduations are not long enough to be read through a window without showing the edge of the dial.

The dial shown in the illustration has a number of new ideas which we have not seen in any other control. The dial itself is of celluloid four and three-quarters inches in outside diameter. The scale is over an inch long and is graduated to the half degree. The whole dial is mounted behind the panel, the scale being read through a bakelite window with a transparent celluloid cover and hair line indicator. The control is supported on the panel by means of bushings through which the vernier knob and the miniature switch project. The condenser itself is supported by means of a heavy low loss condensers. Directly behind the window in the back of the dial) a standard six-volt miniature lamp is attached. This lamp is lit directly from the six volt A battery and is turned on and off by the switch above the window. For wavemeter work there is no reason why this lamp cannot be used as the indicating device, the scale becoming readable when the wavemeter is in tune with the transmitter! The vernier is a ten to one affair, even smoother than the previous Mar-co device. A steel template drill with a series of holes close together is provided for use as a guide for drilling out the hole in the panel for mounting the bakelite window.

This is one of the prettiest devices we have seen in some time. It is called the Precision Illuminated Control and is made by the Martin-Copeland Company of Providence, R. I.

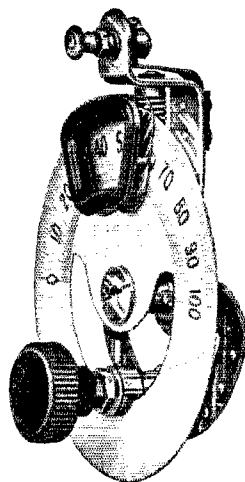

Strays

SCCS tries to use his arm as a rectifier. He puts three thousand volts in at the elbow and it comes out pure D.C. at the wrist with no voltage drop.

npu nrdm nuqg nve vim vis vit wghm wgy wiz wqo
wvc wvy wyy bam ane anf bh did doi pow ocdj
peuu ttn zkn llx lsi 2bg 2lo 6xi.

pi3AA, F. Johnson Elser, Baguio, P. I.

5za 5zai 5abg 5ahp 5akm 5aks 5alt 5amm 5aps
6awt 6bel 6bid 6bjx 6bmw 6bq 6bwi 6chl 6cix 6ciz
6cmg 6cqa 6dad 6fg 6rw 6xi 7vh azyx a3bd a3bq
a3ef a3hl a3kx a7hl bzlan c5go f8jc f8ag f8cg
f8xx f8qq hu6asr hu6axw hu6bdl hu6buc hu6def
ilmt j1aa j1sk j1kk j1ts j2ld j3aa j3ww oa3b x2bg
andir bm glag kel ls npg npu nqv oetij wghm wuq
wux.

y1CD, Ricardo A. Walder, Minas 1721,
Montevideo, Uruguay.

1aao 1aep 1aqp 1bbj 1bes 1bhm 1ckp 1cmp 1xv
1yb 2agq 2ahm 2cxl 2ku 2uz 3bic 3chg 3cjm 4cu 5act
5zai 6bpg 6bvg 6cf 6da 6hm 6oi 6ts 7hb 8bj 8bz
8xe 8bjz 9bz 9cxe 9ck 9da 9drs 9ej 9kd by2 b4yz
bx1 bo2 ear3 ear23 f8tk f8jn f8jw focml fonm
g6yd g2go g2cc g2hs g6pz ilgw ilma nofp nstb
oa5j oa4l oa3k oa5x.

ch9TC, Major R. Raven-Hart, Los Andes, Chile
(now removed to Spain)

1aao 1ads 1aep 1ahx 1alw 1amd 1bbj 1bca 1bec
1bhm 1bjk 1blb 1bqd 1bxx 1cln 1cmf 1cw 1gw 1my
1sf 1uw 1xv 2aao 2agq 2ahm 2buy 2bw 2cxl 2ff 2fk
2ha 2jm 2kg 2le 2nf 2nh 2ol 2zr 3cjm 3hg 3jw 3ll
3mv 3op 4ag 4ai 4bu 4by 4cu 4fl 4hu 4jr 4ni 4pf 4qj
4tv 5aab 5aao 5aav 5aef 5act 5acy 5ado 5aep 5aid
5aij 5ain 5ajj 5akt 5aky 5amj 5amm 5apm 5apx 5aq
5aqq 5atd 5asd 5asy 5aw 5ati 5atp 5att 5atv 5atx 5au
5avf 5awf 5bf 5eh 5gi 5gk 5hc 5he 5hi 5id 5jf 5kk
5ky 5ld 5ml 5nq 5ol 5sw 5uk 5yb 5zi 5ab 5abg 5ad
5adw 5ael 5afs 5aij 5aiw 5atim 5akq 5aks 5akx
5alt 5amm 5anc 5anp 5anq 5aon 5aom 5avb 5aw
5azv 5bab 5baf 5bam 5bav 5bbv 5bcl 5beh 5bhi
5bhx 5bid 5bjl 5bmp 5bpg 5bpl 5bq 5bql 5bat 5btm
5buc 5buf 5bvd 5bva 5bvy 5bwi 5bxc 5bxd 5cae 5cah
5cnd 5cbk 5cbp 5cek 5cel 5cdf 5cgg 5chb 5chk 5chl
5cht 5chx 5cii 5clj 5clx 5cns 5cof 5cpi 5cqa 5cat
5erp 5crz 5cvi 5ct 5cta 5ctb 5ctn 5cto 5cub 5cuv
5daa 5dah 5dam 5dan 5daq 5dat 5dax 5dbs 5dcf 5ddn
5ddo 5dpp 5eb 5fz 5ge 5ha 5hm 5hu 5ji 5js 5kb 5ke
5ky 5lh 5mu 5np 5ns 5nw 5oa 5pv 5pw 5qu 5qw
5rd 5rn 5rt 5rv 5sb 5sc 5tx 5uf 5ui 5ur 5vr 5vz 5xq
5xz 5zd 5zr 7afo 7aim 7bb 7df 7ek 7ny 7pk 7rl 7tm
7yr 7zu 8ads 8afq 8aj 8aku 8aly 8axf 8bgl
8bpl 8bt 8cca 8cdv 8ces 8clo 8dae 8dan 8dfo 8dme
8dpa 8dra 8eq 8gz 8pl 8sf 8uk 8xe 8ze 9aab 9adi
9ak 9alo 9aol 9aot 9asa 9bbw 9bez 9bhi 9bht 9bjk
9bjn 9bjv 9bv 9bvh 9bxz 9caj 9cav 9cbq 9cdf 9cdr
9cej 9cet 9cfy 9ej 9ep 9etg 9ctr 9cvi 9cwn 9cwn
9cxc 9cyr 9czj 9czw 9dau 9dbw 9dcv 9dng 9dpu
9dqu 9drs 9dte 9duh 9dvt 9dye 9eae 9eai 9eas 9ebw
9ecc 9eep 9eev 9eij 9ek 9ekf 9fe 9kd 9nm 9oo 9ph
9pn 9qg 9qr 9ry 9sd 9sj 9ub 9xi 9za 9zd 9zt nkf nrk
kfhv a2ak a2mh a2vi a4an a4cm a4cn a4rb bb2
c1ar c2zb c3xi c4gt c5fc c5go f8brp fden m1aa m1j
m1n m5c oa6n picd8 pilhr z1ao z1fq z2ak z2bx z2gc
z3ai z3aj z4aa z4ac z4ar z4av z4mm fut smvl s2ns sf2.

bzSQ2, Livio G. Moreira, Rua Paula Gomes,
Curitiba.

1aao 1ahv 1ekp 1xam 1yb 1vz 2atk 2egb 2cxl 2ha
2xaf 3dmm 9dzu c1ar ch2ah ch2ar ch2ld ch3ag
ch3at ch3ij ch3ir ear1 f7jn f8rbp g2cc g2lz g2od
h9xa ilgw raal rh09 rd2f ref2 rfa3 rff9 rfg7 rha2
rka9 ylas y1bp yby y1cd y1eg y1ep z2ae pcpp pcil
kel pow wnu nex.

The First Atlantic Division Con- vention at Buffalo

WITH the closing of the three-day con-
vention at Buffalo on June 26, under
the auspices of the Radio Association
of Western New York, the Atlantic Division
was put on the map with a bang, conven-

tionally speaking. Things moved from the
official opening on Thursday, June 24, until
the last minute of the last day, and it was
the unanimous opinion of the 200 hams who
attended that the rest of the Atlantic Di-
vision gang missed something.

The first day was started with the official
opening by A. P. Lawrence, chairman of
the Convention Committee, and a snappy
traffic session under the leadership of Ed
Handy, the new Communications Manager.
This meeting was slated for 2:30 in the
afternoon, but really began with a spirited
discussion about 11 o'clock in the morning,
and constituted one of the best meetings of
the convention. Thursday night was de-
voted to the "Night of Terror" and initia-
tion of certain candidates into the degree
of "I Tappa Key." It was a "hot" time
for those concerned! "Garmy," 3BCK, and
the only YL present, was one of the candi-
dates and proved to the gang that a YL
can be a good sport.

Friday morning was devoted to technical
talks, and immediately after the crowd piled
into special cars for Niagara Falls, first
stopping over at the U. S. Light and Heat
plant, to see 8DAJ, with Bob Collignon in
charge, and to learn how storage batteries
are made. After this a visit was made to the
Niagara Falls Power Company, where we
were told that seven men supervised the
production of the hundreds of thousands of
kilowatts generated there. We were also
presented with some nice booklets and pic-
tures of the Falls by the company.

The real event of the program came off
with the visit to "ol' Niagara," the trip down
to Lewiston on the Canadian side, a "light"
supper there, and a trip back through the
gorge on the American side in time to see
a wonderful illumination and fireworks dis-
play at the Falls.

Saturday morning was devoted to more
technical features with the lecture of Pro-
fessor Hector, of the University of Buffalo,
on electricity, standing out as one of the
best talks presented at any convention. Fol-
lowing the taking of the convention pic-
ture, "Bud" and twenty of his PRR gang
held a hot meeting on railroad emergency
work, and immediately afterward the "Four
Horsemen," of Pittsburgh, conducted an ini-
tiation into the new Pi Alpha Tau radio
fraternity. Ask 8DPL—he "nose"!

With a highly successful and enjoyable
banquet that evening, followed by brief talks
from Lawrence, Handy and Budlong, and
Schnell's slides of the trip of NRRL, the
first Atlantic Division Convention came to a
close. Our thanks to the committee for a
bang-up good time. Oh yes—we nearly
forgot to say that Pittsburgh is going to
have it next year.

—A. L. B.

The Communications Department

F. E. Handy, Communications Manager
1711 Park St., Hartford, Conn.

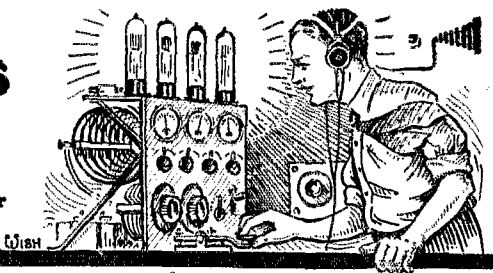

Expeditions

THE Morrissey of the American Museum Greenland Expedition is nearing Greenland as we write. After a session with mal de mer, Manley has had good daily contact with a number of stations. 4RL, 6QL, 9KD and 8AIP were the first stations worked. Mr. Hubbard of 1FD took six messages on June 24, the checks totalling 200 words. On June 28 and 29 2CRB in Brooklyn got QSO, taking more than 600 words of press which was delivered in person to Mr. Putnam. On the first of July, Strout of 2NZ connected on schedule, taking a message and giving the expedition the latest press. 2AEV handled some traffic with VOQ on the same date. Every report to HQ mentions good signals with bad swinging when the Morrissey is in motion. Manley's fine operating is responsible for putting the traffic through even under bad swinging and interference conditions.

VOQ expects to get within 700 miles of the pole to obtain new specimens for the museum. She operates on 20 and 33 meters (15000-9985 kc) to get below the QRM from Navy traffic-handling stations. Manley stands by for general amateur contact daily on 33 (sometimes 37) meters: 8:30 to 9:00 pm EST and 12 to 12:30 am. On 20 meters: 12:30 to 1:00 pm EST and 6:30 to 7:00 pm EST. When VOQ gets into the zone of continual daylight it will be necessary to use 20 meters exclusively. A log of stations worked is kept and the operator making the best showing will get a valuable souvenir from the north—maybe a polar bear skin or some walrus tusks. Please do all you can to help Manley and incidentally gain a few laurels for yourself. Don't forget to report your work in detail to A.R.R.L. HQ for credit in QST.

P. C. Oseanyan, 2AZA, went North with the Morrissey as operator for the Professor Hobbs' party going to Greenland to study climatic conditions. He will use a small B-Battery operated set in Southern Greenland and a special call.

KGBB is the Schooner Schem Third, the second vessel in the MacMillan expedition this year. Austin C. Cooley of 2GY is the operator. The Schem Third is equipped with a standard 250-watt transmitter. Traffic is mainly for the Field Museum of Chicago and the Providence Journal of Providence, R. I. You will find KGBB on 22.5 or 37 meters. 1AYE was the first station to report contact.

WNP, MacMillan's own Schooner Bowdoin, has been handling some of the traffic to the Field Museum of Chicago through Gold of 1AAY at Cambridge, Mass., who can usually QSR direct to 9CEJ at Chicago. 1AAY intends to stick at the key either at Cambridge or Holyoke all summer and push through as much WNP traffic as possible. 1BMS handled messages both to and from Chicago with WNP and 9AAW as terminal stations.

CKA is the call of the Hudson Bay Company's auxiliary schooner Baymaud which left Vancouver, B. C., June 15 to visit the Company's posts in the Arctic Ocean. It is expected that the winter will be spent in the Coronation Gulf. A W.E. 50 water with 500-cycle plate supply on 40 meters is depended on to handle most of the communication with the outside world during the 24-hour day of the Arctic summer.

Traffic from CKA will usually be for the Hudson

Bay Company's Fur Trade, Vancouver, B. C., or Winnipeg, Man. Messages should be forwarded at once by radio with confirmation copy by mail or by collect wire if so instructed by the ship. Reports on reception of CKA should be sent to B. A. Arundell, care of Sprout Shaw Radio Co., Bakers Bldg., Vancouver, B. C., and, as usual, with a copy of the report to A.R.R.L. HQ. c5EJ is the man behind the key, an old timer who has seen things through from the old "spark" days. Let's everyone give CKA a hand, keeping the Baymaud in contact with her Headquarters, Alaskan amateurs can probably help by getting ice reports and giving them to CKA.

Traffic Briefs

7TE, Chapman of Anvik, Alaska, reports that during May when the ice was breaking in all the rivers, their only contact with the world at large was by amateur radio. 7TE has a schedule with 7SM (Nenana, Alaska) and communication with the States via 7SM-6HJ schedules. Information on a sawmill engine and terms on the same were recently obtained from Seattle. The order was put through by radio so that a shipment could be delivered in time for the season's work. Advance word of steamboats with the first mails of the season came to Anvik through 7TE and 7SM. Vy FB! Just another instance of the value of two-way amateur radio.

Don't forget to make use of the Cable Count Check when checking important messages. The check is explained briefly in the Eighth Edition of the Rules and Regulations of the Communications Department. The check is simply the sum of the word count of address, text, and signature.

a2YI says, "It's hopeless to work through the extremely fierce QRM on 37.5 and 38 meters. Why do they insist on being so low when the waves between 39 and 42 are practically vacant?" If you want to pile up some records or work DX successfully and reliably why not take the tip? You are less likely to get into trouble by being logged out of the band, too.

c8KA informs us that the prize for the best-operated station in St. Catherine's has just been awarded. It was closely contested by several stations but finally went to c3DH. Mr. J. W. McCalla, R.D. No. 2, Niagara St., St. Catherine's, Ont.

8ARL (ex8ANJ) has run a regular schedule with C. G. M. Russell, c9AL, ever since things started moving in brass-pounding circles right after the war. A hook full of routine business messages has been cleared at regular intervals.

hu6NL, 6TQ and 6BUC were active in handling details for the Los Angeles-Honolulu Yacht Race. 6NP, 6ZD, 6BMW and 6BVG handled the mainland end of the routes, getting all the information required. Two of the yachts carried radio equipment, WHV and KFWH using amateur-band transmitters.

Wainwright, 6BVG, made a first class record in keeping the Poinsetta, KFWH, in contact with the mainland. Press and messages to all points in the country were QSR'd via amateur radio 9AEK reported KFWH still R4 when worked just before she reached Honolulu. Messages to HQ came through promptly via 6CGW and 1AAY reaching us from Honolulu in less than 48 hours. FB, OM. 6AFS gave Wainwright press from the Los Angeles Examiner taking his share of traffic on June 20.

1AAO, g2LZ and z4AM had a good three-cornered rag chew lasting two hours on the morning of June 28 (12:12 AM EST). They finally quit so 2LZ could go to work, 4AM could eat his lunch, and so 1AAO could turn in for some much-needed sleep—only he didn't!

6CQA recently handled a message to his father when the latter was en route to a convention of Rotarians at Denver. He gave the message to a Salt Lake City ham who met the train and delivered it OK. All the Rotarians were so enthusiastic over the service that they filed a number of messages with 9AAQ in Denver for Southern California and points west. Fifteen of the messages went to points in New Zealand. 9AAQ and 6CQA handled all the business efficiently by using schedules.

9CAA worked 55% of the stations called during the reporting month of April. This is one better than 9CGY's record of last month. Stedman qualifies his report by saying that 162 stations were called which makes the record mean more than one without details.

All official Relay Stations should be sure to report on the 26th of August for the reporting month of July 26-August 25 inclusive. Send your report *direct* to your SCM who is listed on page 3 of *QST* each month. Your SCMs solicit reports from *all* active stations. Official Relay Station appointments will be cancelled if two consecutive reports are missed without explanation. Any reports sent more than one day late will stand little chance of getting into *QST*. Form 1 cards sent to Hartford directly or in error will be returned promptly to the proper Section Communications Manager for inclusion in his report.

6BVG has kept a schedule with p1AU since last winter with hardly a miss.

8BSU-8QY has just taken a Post Office Box to take care of his own mail and in addition to receive "all other improperly addressed amateur mail." FBI! Others who have a P.O. Box will be doing the fraternity a great favor by making the same arrangement with their Postmaster and by properly forwarding the extra mail thus collected.

23 officers and men were present at the annual inspection of the U.S.N.R. 7th Naval District, Communication Division at Winter Park, Fla., on May 19. A code speed competition was held with a first prize of \$10 in gold. M. D. Clark of Jacksonville making perfect copy at 30 w.p.m. won the prize and J. M. Joyner of Orlando making 29 w.p.m. took second prize.

9CPM is lining up stations at Chicago, Lacrosse and Minneapolis to handle weather reports on regular schedules to the Air Mail fliers prior to the time they take off each day. SAIS is doing similar work at Detroit.

Lieut. W. H. Wenstrom (ex5AKT) sailed from San Francisco on the Army Transport "Chateau Thierry" July 2nd bound for New York by way of the Panama Canal. He will use the transport's call, WXF, on 36.5 meters for contact with amateurs working *within* the 37.5-42.8 meter band. A schedule with 5AKY will be kept at 6:00 am MST daily.

We are unable to print full reports from the Central and Midwest Divisions this month as the main reports have not come through on this, the date of closing Communications Department *QST* forms. Next month the reports will appear by Sections. If every SCM sends in his report on time as requested, we will be able to run a complete C.D. next month. Your new SCMs have lots of responsibility. Be sure to get in a report to them on time.

8ZE worked 62% of the stations he called in the last two months—the record so far. The log also shows that on CQ calls from 8ZE, 85% are answered. Most of his CQs are directed to some specific place in agreement with ARRL standard practise. Such results show that good judgment in calling and CQing is well worth while.

Club Activities

CALIFORNIA—The Santa Clara County Amateur Radio Association has started to build up a good fund for the coming Pacific Division Convention. During the floral parade at the Fiesta de las Rosas the gang ran a float which copped second prize. The sale of hot dogs and soda pop at the club stand cleared a substantial profit—an FB suggestion for other clubs in building up the treasury department. At the carnival grounds 6SV handled many messages for visitors.

The Los Angeles Radio Club is coming to life again under the leadership of Jay Peters. Club rooms are being fixed up and a real club is promised.

A new section of the IRE has been organized in Los Angeles with about 50 members. Monthly meetings are held and a real group of serious radio men are having some very worth while meetings. 6BQX is chairman, 6LJ vice-chairman, and 6BUR is Sec'y-Treas.

SCM Smith visited the Silver Gate Radio Amateur Ass'n at San Diego recently and found things running smoothly and with lots of pep.

CONNECTICUT—A number of members of the Twin City Radio Club took the examination in New Haven June 8th and now hold "ham" tickets. The Club is cooperating with the Radio Supervisor to keep BCL QRM at a minimum. 1AHG, 1ATH, 1AUU, 1AUK, 1AXZ, 1BAU, 1BOA, 1BEM, 1BJK, 1BJR, 1BQH, 1CHL, 1CTP, 1FY, 1LQ, 1TD, and 1WN are active members on 40 or 80 meters. Mr. R. H. McKendrick, 46 Center St., West Haven, Conn., is Sec'y and requests communications from other clubs giving transmission data, club activities, etc.

ILLINOIS—Mr. Halvorson (9RK) and Mr. Tresidder (9AAW) have been elected Treasurer and Vice-President of the CRTA in place of the resigning officers. President Hinds is touring the East and called at ARRL HQ recently. The Peoria Radio Amateur Assn. invites Illinois amateurs to the State Convention August 7-8 and the CRTA have a special committee to plan their part of the Convention work.

INDIANA—The Bloomington Amateur Radio Club is holding bi-weekly meetings. Code practice classes are open for everyone in the city interested once a month. A club station is planned. Mr. Robert Laymon (9AYO) will welcome any information that will be of interest to club members or helpful in planning station or activities. 9ABW and 9AIN are the president and vice-president.

LOUISIANA—The Caddo Radio Club has just organized and held two semi-monthly meetings that were very successful. 5ANC was elected President while 5ML, 5AGJ and 5WY serve as Technician and Communications Manager in addition to their capacities as Vice-presidents. 5AKI, 5APA, and 5WB are on the technical committee.

MAINE—The Queen City Radio Club announce a club trophy contest. A cup is to be given the Maine station handling the largest number of messages for the three months beginning July 26 and ending Oct. 26. The messages must be genuine traffic handled in accordance with the Rules and Regulations of the A.R.R.L. Communications Dept. The winner of the contest must submit his messages for inspection at the close of the contest. The judges are the officers of the QCRC. The cup is over one foot and will make a beautiful addition to some ham shack. Who will be the lucky man?

On June 11, the Club had a banquet and invited the Bar Harbor gang, who sent a good representation. The QCRC Trophy was announced and the Trophy was on display. The Harbor fellows have invited the Queen City organization to a clam-bake, the date to be announced later.

MINNESOTA—May 22 the Twin City Radio Club held a final meeting and party for the year in the form of a picnic. After a busy day with various sports, quantities of hot dogs, and coffee were consumed. The bunch enjoyed a pleasant evening swapping radio stories before the bonfire. Everyone joined in the singing. 9ZT, 9RVW, 9BIS, 9BAY, 9CIW, 9ULI, 9EF, 9BZP and numerous YLs were among those present. 9OY, 9EF and 9CRW were responsible for putting the picnic across.

NEW JERSEY—The Eclipse Radio Club holds monthly business meetings during the summer. The Club house is open nightly for the gang.

NEW YORK—The Queens Radio Club reports rapid growth. A code instruction class insures that a good number of new fists will be on the air. Every member of the Club is busy getting new subscriptions to *QST*, turning them in to HQ in the club name so that the club will soon have a new wavemeter.

The Yonkers Radio Club members are also after the *QST* wavemeter for their station. Every member recently brought some apparatus to a grab-bag and the Treasurer collected a nickle a chance. You should have seen ZDD's expression when he drew the galvanized iron condenser.

OHIO—The Hamilton Radio Assn. have 8CGT on the air handling its share of ARRL traffic, on 40 meters.

PENNSYLVANIA—The Mahoning Valley Amateur Radio Club of Warren, and Youngstown announce 8DPQ as the call of their new club station, located half-way between the two cities.

The Amateur Transmitters' Ass'n. have presented a resolution to the Bureau of Standards asking that WWV standard frequency transmissions be continued indefinitely.

June 12 the Landsdowne Radio Association held a banquet at McCallister's Restaurant in Philadelphia. Attendance from other radio clubs was gratifying. Representatives from clubs in Brooklyn, Bronx, Ridge-wood and South Jersey with those from local societies brought the total to 125. It was one of those rare banquets at which no one had a chance to complain of the food which was good and plentiful. Addresses were made by Dr. Lee DeForest, Mr. Van Housen of the Philadelphia Public Ledger Radio Department, Dr. Lawrence Dunn, Director of the Hudson Division of the American Radio Relay League, Mr. Joseph Nassau of WOO, Mr. Boyd Phelps of Richardson Radio and Robert Kruse of *QST*. Amateurs of all sorts were present from the vicinity of Philadelphia and of New York City. The speaking was followed by dancing, also by a professional entertainer, who burlesqued well known broadcast announcers and gave an imitation of a five piece brass band without using any instruments at all. This chap belongs on the Keith Circuit.

RHODE ISLAND—The Providence Radio Ass'n had their last meeting before fall June 24. The gang turned out in full force for a smoker and hamfest. Mr. N. Keas, who spoke on "Radio Vision" at the New England Division Convention, drew a good crowd at a recent meeting before the smoker.

SOUTHERN TEXAS—The Bexar County Radio Ass'n is planning another Big Hamfest about Aug. 7-8. Those of us who have attended these before are anxiously looking forward to this event.

Notice

To all A.R.R.L. Members of the Northern Section of the Pacific Division, Ontario Division, and Quebec Division.

The sectionalizing of the territory in your Divisions is now indicated as follows:

Northern Section, Pacific Division (five sections as follows): Section 4, Northern California. Section 5, Northern California (less Sonoma, Mendocino, Marin, and San Francisco counties). Section 6, Northern California, Sonoma—Mendocino—Marin—San Francisco Section. Nevada Section.

Ontario Division (one section to be known as the Ontario Section).

Quebec Division (one section to be known as the Quebec Section).

Nominating petitions from these three Divisions are hereby solicited for Section Communications Managers giving the membership an opportunity to confirm temporary officials listed on page 3 of *QST* or to elect new officials to serve. The proper form for nomination was shown on page 45 of April 1926 *QST*. The candidate and at least five signers of a petition must be members of the League in good standing to make any nominating petition valid. There is no limit to the number of nominating petitions which may be filed but no member shall have the power to nominate on more than one petition.

The closing dates for the receipt of nominating petitions from the Sections listed above (with the exception of Sect. 4, No. Cal., where the results of the call for nominations was reported last month) are as follows:

Section 5, Northern California (less the four counties named), noon, Dec. 15, 1926. Section 6, Northern California, noon, Mar. 15, 1927; Sonoma—Mendocino—Marin—San Francisco Section, noon, June 15, 1927; Nevada Section, noon, Sept. 15, 1926; Ontario Section, noon, Sept. 15, 1926; Quebec Section, noon, Sept. 15, 1926. Elections will be held in the Sections named immediately after the dates given if there is more than one nominating petition on file so that it is necessary.

This notice completes the call for nominating petitions for SCMs in every section of every Division, a call made necessary following the action taken by our Board of Directors at their last annual meeting. As fast as elections take place, the names and addresses on page 3 of *QST* will be revised indicating permanent officials and their addresses to whom any station-owner can send a report on the 26th of each month. Official Relay Stations are of course *required* to report to these officials monthly if they desire to hold their appointments valid. In two years it will be necessary for the Communications Manager again to call for nominating petitions in these same Sections as provided in our Constitution. Next *QST* will carry a list of Sections and closing dates for the receipt of nominating petitions (extended if necessary) in Sections where the A.R.R.L. members have not yet taken the necessary steps to secure permanent officials.

Members are urged to take the initiative immediately and to file nominating petitions for the officials of each Section now operating under temporary appointees.—*F. E. Handy, Communications Manager.*

 * Robert E. Harris—5TW *
 * 708 W. Duke Street *
 * Hugo, Oklahoma *
 * Orig., 124; Del., 97; Rel., 294; Total, 515. *

BRASS POUNDERS' LEAGUE

Call	Orig.	Del.	Rel.	Total
5TW	124	97	294	515
8EU	50	29	416	495
1BIG	35	25	360	420
6BQ	16	4	208	228
8XE	22	2	190	214
8AYP	69	52	77	207
8GI	13	64	124	201
8DBM	55	34	91	180
6KY	75	62	40	177
4MV	20	6	133	159
6AJM	28	113	12	153
6BJX	52	31	64	147
1AAV	7	18	120	145
1AUF	11	6	123	140
8BSZ	20	23	94	137
8RY	17	7	108	132
8AHK	2	2	128	132
8DHX	24	24	78	126
8CNX	62	16	46	124
1BMS	11	21	82	114
8GZ	58	33	20	111
8AHO	53	39	17	109
1AFO	43	42	24	109
6NP	52	17	39	108
8AVK	28	11	63	102

There was certainly a close race for the starred rectangle this month. For a while we thought 1BIG was ahead. Then 8EU's report came along. At the last minute 5TW came to the fore with a handful of extra messages. He kept 22 separate and distinct schedules! 6BJX dropped a few on account of sickness but assures us that he is handling the regular fifteen a day and will be in at the finish next time. 6BQ and 8XE have pulled up into fourth and fifth place. There are fewer stations making the BPL this month but the competition between the leaders is keener than ever. 8GZ handled over ten thousand words of real traffic. 1AFO handled a bunch with NIDK. 6AJM made the highest percentage of his traffic, "delivered" traffic. FBI! It means something to be in the Brass Pounders' Column these days.

The most recent word of our success in the Australian Reliability Tests came via 2yi, usgz, and usdpl (Zauh at the key) on the opening day of the Atlantic Division Convention. Here is the substance of the message:

HR MSG FM SYDNEY AUSTRALIA 2YI VIA COLUMBUS OHIO 8GZ NR 56 JUNE 24 CK 118

TO F E HANDY
CARE ATLANTIC DIVISION CONVENTION
BUFFALO NY

YOUR REPORTS RECEIVED STOP ADDITIONAL USA STATIONS QUALIFYING TRANSMISSION OF OFFICIAL MESSAGE 2UO 6RW 7AAB 8AJ 8ADN 9ZT 9DRD 9DNG 9EBT 9EFC STOP PARAGRAPH HANDLING MANY THOUSANDS OF WORDS UNDER WORST CONDITIONS MOST WITHOUT ERROR IS BIGGEST STUNT EVER IN OUR AMATEUR WORLD STOP IT MAKES ONE REFLECT ON CONDITIONS A FEW YEARS AGO STOP THE ARRL AND QST HAVE LED THE WORLDS AMATEURS TO A WONDERFULLY HIGH PLANE OF ACHIEVEMENT STOP MAY THEY EVER LEAD ON STOP END

HULL WIRELESS INSTITUTE AUSTRALIA

DIVISIONAL REPORTS

ATLANTIC DIVISION

MARYLAND—3APV reports he is checking up on amateurs below 37.5. 3KU is going to Arizona with the National Geographic Expedition. 3CGC has been QRW school and track work. 3OP is working all over the globe with a single 60. 3ACW is on again with a fine punch. 3FB is back in the game on 83 meters. 3GT is having trouble getting the WE50 perking on 40. 3VI is kicking out FB on 40 and 80. 3WF has been QSO J-1DO. 3SF is still experimenting with antennas and works great DX. 3AHA is working foreigners in every direction with pure DC from Kenotrons. 3DT has built a fine 40-meter rig but is seldom on. 3AOJ is breaking records with the ol' fiver fed with RAC. 3PH is still rattling foreign cans. He is going to install a mercury arc rectifier. 3DW has a beautiful 250 watt set on 80. 3LG is inactive at present but will be back in the fall. 3AEA is FB on 40 and 80. Midshipman Offutt of 3BUR may have a 100 watt outfit going on 40. Midshipman Jordan will operate a new crystal-controlled 38.7 meter rig on NVE during the Utah's cruise between Portland, Me., and Guantanamo, Cuba, providing the outfit does not QRM other receivers on board. 3LL, in his new location, is working FB now. 3WA is reaching out well on 40 and 80 meters. 3HG is pining for a QSO with Asia, the missing link in his WAC chain. 3RP is still making the UX210 do its stuff on 39.

Traffic: 3FB 12, 3APV 21, 3RF 16, 3GT 3, 3HG 20.

EASTERN PENNA.—H. M. Walleze, SCM—Greetings, men! My heartiest thanks for your fine support and the many good wishes, offers of co-operation, etc. FB! I hope that I will be able to "fill the bill" for you. Any suggestions, bricks, questions or anything at all that you may have in mind along our work, shoot them in. We want to set the pace for the rest. That means 100% co-operation and work.

3CBT and 3QT "op" at 3ZO daily keeping two ten hour shifts. They want schedules with anyone who has msgs. east between noon and 8 am. Don't forget to give your QRM.

WARNING! New ORS certificates are going to be issued—to ACTIVE stations only. Just 40 ORSs failed to report for June. You will have just TWO more chances to show that you are active. Applications wanted by the SCM for ORSs, Official Observers (accurate wavemeters required), and Vigilance Committees.

3EU leads us as usual and says all his traffic was important. 3BSZ, 3AVK and 8AHO made the BPL also. 3BWI says QRN is bad. 3LW handled a couple of 500 worders to and from A and I. 3BLC is busting out. 3AVM lost his H tube, but is back with some 5ers. 3AIY handled Police messages to Chi. 3AY worked Gm but says QRN is bad on 40. 3VT is QRW building a real Low Loss ORS. 3JN sent a lot of dope in. 3CP is a new station. 3AJC is getting a MK7 juv. 3CTZ is on at times. 3HD's QW has him at house cleaning. He handled some Sesqui traffic through it all. 3CFT had his call

changed to 8CW and likes it fine. 3RT and 8AOL are working for WAC tickets. 3COR is moving around. 3BIT is punishing 40 with his 250 but can't find much traffic. 3AR is on the job as usual. 3FS kindly shipped in a load of reports that he received. 3CCQ is home from 8XE and is rebuilding. 3AWT says he is no DX baby. 3BFE found new love in a Ford. More or less QRM, for Williamsport? 3LK QSRd traffic direct to Balboa via NBA. 3AVK says 9BAF expects to locate in Williamsport. Welcome, O.M. 3CGZ is QRW trying to filter his MG-DC. Your SCM sold his MG and will be off until he can get another. 3AHJ is back on 80. 3SM-ATC is back from sea. Old spark, 3UF revived and will be going on 80. 3CZQ and 3AIG want ORSs. 3ZM has a new station on 40 and 80 meters. 3PY reported but no activities. 3CHG is "op" on the S.S. Howard.

Traffic: 3EU 495, 3BSZ 137, 8AHO 109, 3AVK 102, 3BQ 33, 3AIY 21, 3CGZ 20, 3AWT 12, 3LW 11, 3BIT 10, 3AY 10, 3RT 9, 3FS 8, 3BFE 8, 3CFT 6, 3BLP 6, 3LK 6, 3JN 5, 3HD 4, 3CCQ 4, 3AVM 2, 3BLC 2, 3BWI 2, 3AHJ 2, 3ZM 10, 3PY 4

SOUTHERN NEW JERSEY—H. W. Densham—SCM—Traffic reports fell off this month due, perhaps, to the reorganization. In the future all ORS should report direct to the SCM. 3OQ is coming back on the air early in the fall to push that signal of his around the world. 3BO is temporarily in Reading, Pa. 3BWJ has a crystal-controlled set on 41.5 meters. 3BAY built a new set that takes all honors for workmanship. He will be on the job soon. 3VX worked Brazil nightly in spite of the summer season. 3JW is working schedule with pr4KT. Send him your Porto Rico traffic, gang. He is also QSO Brazil regularly. 3KJ runs a Sunday schedule with 8UT. W. W. Filson has been appointed Official Observer and C. H. Jenkins is the new Route Manager in the Camden district. 3SJ has a transmitter going on 40 meters. He is teaching his sister the code. FB! 3ABF reported but no activity. 3BTQ will be on, now that school arm is over. 3CFG worked 7 districts on a 201A with 5 watts input. 3ZI reports activities slow around Trenton. 3BMS is closed for the summer as he has gone to Europe.

Traffic: 3KJ 1, 3AS 14, 3JW 23, 3VX 1, 3BWJ 1, 3SJ 4, 3ABF 1, 3BTQ 6, 3CFG 17, 3XAN 3, 3ZI 1.

DELAWARE—H. H. Layton, SCM—Mr. H. H. Layton is acting as SCM pro tem and asks your co-operation. ORS in Delaware should report direct to him on the 26th.

Felton, Del. has a new low power station with the making of a good ORS. 3AIS put up a new antenna and using third harmonic, seems to get out better than ever. Traffic moved faster during the past month. 3WJ returned from a trip to the west coast on the Gargoyle (KDPE). He had a 40-meter transmitter with him and did good work with it. He is now on one of the M & M boats poundin brass. Yes, the old reliable is along, too. SL is the proud owner of an ORS certificate. He is a good operator and craves traffic also. The SCM expects to call at HQ July 17th and meet Mr. Handy himself.

Traffic: 3AIS 17, 3WJ 6.

DISTRICT OF COLUMBIA—A. B. Goodall, SCM—Traffic stations outside of the Dist. of Columbia need not worry about the disappearance of 3BWT from the air. After working consistently 1 year, Ep is taking a much-needed month's vacation. During his absence we have 3NR on the job. 3ACM is representative of several stations in the District. 3AHP is back on the job on 40. 3CDQ "QW" is going to Europe for the summer. 3JO is going to camp for a couple of months.

Traffic: 3AB 17, 3ACM 10, 3BKT 14, 3NR 14.

WESTERN PENNA—Gilbert L. Crossley, SCM—Activity in this Section seemed to be very slack in the last month, judging from the reports turned in by the different stations, the non ORS sending in more reports than the ORS. The traffic handler also seems to be rather light, perhaps due to summer weather and the static months.

8AGO, 8BRC and 8EW report PRR traffic as being their most important. 8CLV is rebuilding his transmitter and putting in a Hertz. 8EW has been bothered some by a cracked crystal. 8BW blew his tubes. 8GK and 8CC report some foreign work that is interesting. 8DOQ tried 40 meters for a while but is now back on 80. 8ACQ reports off duty for the summer and 8AMB will be with 8BRC to help keep the ether hot. 8BRB has been on the job with a few rush messages in the last month. 8CWQ is moving as well as 8AAI but both of these men will be on again soon. 8BUN, 8XE, DTS, DTX, AIF, ASU and CTB report activity through 8BRC. 8CGP is having his own time trying to set up a transmitter out on a farm with no 110 available. 8XE will not be active this summer, due to considerable construction work going on at the station. 8BOY is off the air due to a blown tube. 8CMP is spending his summer in Europe and will probably visit a few foreigners while there.

Traffic: 8DOQ 1, 8AGQ 4, 8AXD 4, 8GK 6, 8CGF 7, 8EW 27, 8BRC 45, 8CWT 50, 8AGO 29, 8BRB 53, 8XE 214.

WESTERN NEW YORK—C. S. Taylor, SCM—Well, fellows, the YLs and the first Atlantic Division Convention which was held in Buffalo has passed and gone but will never be forgotten. Thanks to the Radio Association of Western New York, and ARRL Headquarters, officials who put the affair over in the most perfect style, The Atlantic Division, Western New York extend a vote of thanks to all the speakers and members of the League who helped in making the Convention a success and invite all to be at the next Atlantic Division convention which will be held in Pittsburg, Pa. sometime in June, 1927.

Western New York stood solid in their support of the SCM, Chas. S. Taylor and had a 100% attendance at the Convention which shows the type of men in the Western New York Section. While the gang was enjoying themselves others have been working hard to pick up the sins of American hams on the other side. Director Woodruff has a little set with him in Europe and Mr. Lidbury of 8DAJ, also has taken along a receiver. 8MU has been busy working Brazilians. 8DDL has been working Africans. 8CQV is rebuilding for lower wavelengths. 8NT has worked the Belgians and says 19 meters is the berries. 8CYL is back from college and worked six Australians in 1 1/2 hours. 8BGZ has been doing a little Naval work. 8DPL worked 8CQZ with 4 volts on the plate. 8BQN has moved to Geneva, N. Y. 8BKQ handles traffic. 8DRJ worked 24AM, WNP, DVI. 8QB is still with the PRR bunch. 8AYB and 8UL are still after schedules and traffic. 8BNX leads in traffic again. 8VW and 8HJ still pound out message traffic; 8BHM says foreigners pound in at his place in great style. 8AHK, now an ORS, worked 211P. 8ARG works 6s quite often. 8AFQ has been reported in England using a 7 1/2 watt. 8DSI has been handling traffic again. 8AGM ex 2BSL has a portable up in the Adirondacks and would like schedules with the gang. 8DBQ has been in a rampage over in the wilds of Canada. 8DBC has been to N. Y. City on a visit to hams. 8AVB will be hamming strong soon. 8CNX is now operating a tub on the lakes. 8BIN is experimenting with a Hertz antenna. 8CTL has his Hertz working. 8BMJ, using a 50 watt, has worked every district but the 7th. 8AVR popped his 203A but has an extra which will pound out soon. 8AWP is operating WMAC now at Cazanovia, N. Y. 8BSF expects to change over to crystal. 8AOM expects to be on soon. 8CTK's report was so large this month, he hasn't finished it yet.

8RV went goofy over his flivver and also neglected to report. 8PJ doesn't have to report for himself any more. Hi.

Traffic: 8CNX 124, 8CTL 8, 8AHK 132, 8DHX 126, 8DRJ 12, 8BYX 16, 8DKN 6, 8DPL 29, 8BCZ 15, 8CYI 9, 8NT 14, 8HJ 4, 8ARG 5, 8BHM 34, 8BSF 4, 8DSI 10, 8AYB 4, 8GB 29, 8UL 16, 8VW 14.

CENTRAL DIVISION

C. E. Darr, Mgr.

OHIO—Dist. 2—Traffic is moving in good shape this month. 8DBM takes the lead. He has schedules with 1BIG, 8GI and 8RY. 8RY worked KEGK and has schedules with 8DBM and 8CVQ. 8ZE worked O-RR2 in French for 45 minutes on June 2nd. 8BKQ has only been on a couple of times this month as his crystal blew up. 8AJZ, 8WE and 8BXQ are still off the air owing to various reasons. 8BCE worked A, F, HU, O and Z this month.

Dist. 3—8DIA has been working on a sked lately and says its FB. 8BPL has been QRW lately so the traffic total suffered but he managed to grab off a few minutes to work some Aussies. 8BKM has a new portable call, 8BNM.

Dist. 5—8GZ handled 111 msgs this month totalling 10,192 words, cable count, which Windom thinks, is another record. 8DSY blew his fiver and is going strong with a VT14. 8PL has just installed crystal control and says its FB. 8CBI got spring fever. 8DEM has been having the worst luck with masts in the U. S. but has a Hertz going now. 8BNA's DS wouldn't put his reports in QST so he sent them to Dist. 5, hoping he'd get some mention. 8BBH blew his outfit up and lack of funds have put him out of commission for a while. 8BYN looks forward to a busy summer season if he duplicates his work of last summer. All the above stations except 8DEM and 8BBH are keeping regular schedules with one or more stations and there ought to be more of this kind of work.

Dist. 8—8CPQ routed his report direct to HQ as his DS fails to get them in QST.

Traffic: 8DBM 180, 8RY 132, 8ZE 7, 8BKQ 1, 8CLR 9, 8DIA 51, 8BPL 11, 8BKM 11, 8AWX 5, 8DRX 3, 8CPQ 20, 8GZ 11, 8DSY 20, 8PL 16, 8CBI 9, 8DEM 7, 8BNA 7, 8BYN 36.

WISCONSIN—Dist. 1—8BKR has more time for radio now that school is out. 9ATO handles Army traffic with 9AFF. He is the only alternate Army station in the 6th Corps Area to receive a gold star for consistent work. 9DTK says schedules have all gone kiting. 9BWO was QSO NRK and Hawaii five times since last report. Visitors lately have been 9CKC, 9CNB, 9AAW, 1CON. 9DVG is back from school and will operate at 9BWO this summer. 9CDDT put up a new counterpoise. 9AFZ finds a little more time to get on lately. 9EHM is almost thru with his new station and hopes to be on to handle traffic soon.

Dist. 2—9OM reports summer QRM. 9BIB's crystal set is still perking along merrily. 9EAR has a new cage antenna with three wires. 9EAN just returned home from U of Wis. 9XH-EK would like to get more traffic to handle. 9DLD says he had a great time at the Roundup and is waiting for the picnic at Delafield.

Dist. 3—9AGV applied ORS appointment. 9AEU just got back from school, so we hope to have a good report next month. 9DHG sends in an interesting report. 9BVA does not find much time to operate. 9CIU has a commercial ticket and hopes to get a job on the Lakes. 9DKA has enlisted in the USNR and is now on a trip thru the northern part of the state. 9AZY is having tough luck with his xmitter but says that he will have a large total for next month.

Dist. 4—9AZN had schedules with 9BLF at Camp Sparta till a 50 watt blaw. 9BLF kept regular schedule with 9AZN till the 50 went west. 9AKY is not on the air much but assisted on the army traffic for a few days. 9ZY has completed the new xmitter and it works fine on 40 and 80. 9CAV and 9CFT are two new stations at Scofield.

Dist. 5—9ELI attended a picnic and weiner roast at Minneapolis and says he will attend one of ours if we can show him as good a time.

Traffic: 9BKR 35, 9ATO 27, 9DTK 26, 9BWO 15, 9CFT 9, 9AFZ 7, 9BIB 3, 9XH-EK 15, 9EAR 3, 9AGV 4, 9AZY 3, 9AZN 47, 9BLF 26, 9AKY 5, 9ZY 2, 9CAV 5, 9CFT 4, 9ELI 19.

DAKOTA DIVISION D. C. Wallace, Mgr.

THIS Division goes over to SCM reports after this month. In this issue, you will find instructions which are to the effect that the ADMs will act as SCM's until their successors are duly elected. Report to your SCM pro tem as follows:

Minnesota—Cy L. Barker, Henning, Minn.
South Dakota—M. J. Junkins, Bryant, S. D.
North Dakota—G. R. Moir, Care Radio Equip. Corp., Fargo, N. D.

SOUTH DAKOTA—9CKT, who is attending Harvard for the summer, started out in the car and hopes with good luck to return in it. 9DIY and 9ALN are both off the air consistently. 9AGL reports the crystal set working FB but he and 9BRI are leaving for the west coast to get commercial jobs for the summer. 9NM has been working A, Z, O and HU stations. 9DZI is leaving for National Guard camp and will be off the air for a time. 9CJS has considerable local QRM in the shape of a new ten pound YL and consequently loss of sleep. 9RKB put up a Hertz antenna and says it's FB. 9DID has 100 watts going with fine reports. 9BDW-DB built a portable transmitter and receiver for a camping trip and reports twelve pounds total weight and reports hearing A's and P's on a 7 x 10 inch loop. 9BBE changed over to a FKUH transmitter and works Aussies and Zedders every night. Tried a new 200A detector and says it picks up all the power leaks in town and some that are out of town. Traffic: 9BDW 24, 9DID 2, 9RKB 1, 9NM 24, 9DIY 1, 9CJS 6.

NORTH DAKOTA—Between summer, automobiles and YLs, the traffic total has suffered a setback this month. 9DM is back home after finishing the school year and is going good once more. 9BJV reports high line QRM so bad as to be impossible to do much. 9CRB would like to arrange schedules with hams after 12 midnight. 9DKQ is on the air with a new 30-meter set. 9EFN is building a new house and finds it hard to do much with the set all torn up but will have a new set going soon. Traffic: 9CRB 2, 9BJV 1, 9DM 6.

MINNESOTA—Dist. 1—9EGU'S rebuilding is still in progress but the station is on the air occasionally "in between times."

Dist. 2—9MB, 9COF and 9BBV will be off the air until fall. 9COS has trouble getting adjustments on a defective H tube. 9RTY has rebuilt his set. 9EGG is getting back on the air. 9CAJ has ditched his 5 watt and put in a UV203A. 9AIR made a two weeks trip through the northern part of the state and made it more interesting by carrying a portable SW transmitter and receiver. 9BNF remodeled his transmitter into a panel mounted affair and has the same kick. 9DRW has been QRW with examinations, but managed to be on the air at times. 9EHO is just ready to come back on the air again. 9GZ has 100 watts with MG and is soon leaving for a USNRF cruise. 9AWN will be flying with the US Navy this summer. 9CPO is back on the air with a 5 watt and 40 meters.

Dist. 3—9DAW is on the air again after some absence. 9CPM says he is QSO 4 out of 5 foreigners. 9CCX is rebuilding, converting to crystal control. 9DGE can only put in a few days per month with his set. 9DHP is having trouble with his set. 9ECC put in KFUH circuit and works everything he hears. 9SE is still off the air but expects to be on before July 1st. 9CZQ lost his license so will be off indefinitely. 9RNB and his 7 1/2 watt set seems to work out just as well as his old 50 and MG. 9ABK's licenses expired and he is now 9DH at the same address. 9BMX and 9BVH are both using Hertz antenna systems on the 40-meter band. 9ZT was reported 2nd station in US to send 500-word test messages to Australia, and first station to receive the 500-word message from Aust.

Traffic: 9ANJ 5, 9CAJ 5, 9BDW 31, 9AIR 4, 9BFW 11, 9GZ 1, 9RKK 4, 9ZT 68, 9GH 3, 9ASW 4, 9BVH 4, 9DH 1, 9ECC 56, 9DHP 7, 9DGE 3, 9CPM 38, 9BNC 13, 9BAY 7.

DELTA DIVISION B. F. Painter, Mgr.

TENNESSEE—4BU has discarded his "terrible" sync and now has a smart MG set. 4CU is reported to be interested in master oscillator sets. 4EO blew his UX210 and now uses a WE 50 watt. 4FW is QRW with night work. 4FA bought a WE 250 but hasn't got started yet. 4JJ moved about town several times. 4PZ just got a 500 cycle outfit and pushes out well. 4JN is on a trip to Europe. 4IV has been busy with college but operates fairly regularly. 4GS is a new 5 watt station. 4LE uses 50 watts and 500 cycle stuff. 4HL got a DC note out of chemical rectifier. 4AJ is installing a 50 watt. 4GC is just getting on the air with a 7.5 watt. 4EE has just installed a 250. 4HP is still getting out with his 201A. 4MM is taking a portable transmitter to the Army camp call 4VV. 4FP is moving and will do better work.

Traffic: 4EE 10, 4GC 8, 4AJ 19, 4HL 11.

LOUISIANA—During the Australian tests, 5ML received 4 Australians, 9NZ's and 4 unknown stations on a loop antenna using his short-wave super. 5ACY states that he would have had a perfect month as he worked his first A's, Z's and CH's but his H tube expired. 5KC is back on the air again using two UX210.

Traffic: 5ML 4, 5ACY 15.

ARKANSAS—5WK suggests that the gang hold prayer meeting one night a week. He is installing MG and will be working on phone soon.

MISSISSIPPI—5QZ states QRM from QRN. 5AKP states that his transmitter goes Democrat every two or three days and quits. Guess he must be a Republican. 5AGS is now at the BSA camp with his portable transmitter. 5AGS, 5ARB and 5AQU. 5AGM will have a real report next month. 5ALZ is bac krady for traffic. 5FQ is working on 40 meters.

Traffic: 5AKP 23, 5QZ 3.

HUDSON DIVISION E. M. Glaser, Mgr.

THIS is the DM's last report. All ORS now report direct to their SCM's pro tem until an SCM is elected.

NEW YORK CITY—Bronx—2ALL is QRW school. 2ALP has been out of town. 2APV is the first Bronxite to get a WAC certificate. 2AYD and 2BHC are new stations on the air. 2BBX worked Java on a 210. 2CYX was at the Phila. banquet and at Buffalo. 2ASA blew his ole faithful 201A and is getting a 210.

Brooklyn—2BBW is a new station using a 210. 2AQW is going down to 40 with his big bottle. 2AOF is off until he gets a new bottle. 2APD is on 39 meters. 2UD has hopes of getting a crystal going. 2CLA can be heard on 84 meters with a beautiful crystal note. 2WC can be heard on 80 and 40 with his pretty outfit and now 2BRB has his crystal going on 79.2 and 39.6 meters. 2PF is busy with the Army work but can be heard on 39 meters handling traffic.

Manhattan—2EK has gone to the west coast. 2APJ is handling some traffic. 2ALS has a crystal on 81 meters. 2EV has a new receiver and works more foreigners than U.S. 2LD is putting in a new antenna. 2BNL has been taking advantage of the summer in his Lizzie! 2CHK isn't on much for the same reason.

Bronx—2AKR has been QRW on account of the fine vx and the yls at the beach. 2AKK has been off on account of high school exams. 2AYW has been trying to get his spark coil ICW going but ND. 2AYH is getting a new receiver. 2CEV has arrived home from Africa where he sailed as Com'l op. 2CEP is rebuilding and is going to try for the HPL. 2AFV rebuilt and hopes to be on all summer. 2SL is a new station in West Brighton with four 202's. 2ATQ is getting a fiver so will be QRW until the craze wears off. 2CPG will be on this fall. 2AKK, 2AKR and 2APV play checkers by radio. 2AXI is a new Hall's station. 2AQB is doing fine DX work. 2BSL will have portable 8AGN this summer. 2AEV is the place to send reports.

Traffic: 2ALL 6, 2ALP 34, 2APV 32, 2ASA 20, 2AYD 9, 2BBX 18, 2CYX 44, 2BO 9, 2PF 6, 2APD 13, 2AQW, 2CHK 5, 2BNL 2, 2LD 8, 2EV 16, 2ALS 23, 2EK 16, 2APJ 63, 2AWL 2, 2AEV 23, 2AXI 8, 2BBI 4, 2BSL 2, 2AKK 2, 2AKR 5, 2AFV 30, 2CEP 2, 2AYW 2, 2CZN 16.

EASTERN NEW YORK—Yonkers—Having built the low power 4-battery transmitter for the Putnam Expedition, 2CTF is putting in a 1/4 kw. tube on 20

meters. 2AAN worked Morocco, Luxemburg, Australia and NZ. 2AJQ has tuff luck getting out and continues to try everything under the sun. 2ADH is in about the same fix and has such a rotten antenna he gets out just as well without it! 2DD put in some kenotrons but still sounds like raw AC. 2CIL got home from Europe with a dollar and fifteen cents and had to leave his short wave set to the mercy of the fishes because they wouldn't let him take it ashore in Venice. 2CBG has joined the Ancient Honorable Order of Benedictis. 2ASE bought a fiver that only lasted one night, but worked 6JY with it.

White Plains—2CNS has had an off month but says he copied a whole msg from Radiokouler Santa Hamina, Helsinki, Finland to Portugal. 2AAZ has been QRM school exams but will be on more regularly now. 2BQB is tied up the same way. 2LA is sure making Larchmont hum. The Larchmont Radio Club has 2BQH, 2BSA, 2ALT, 2JE, 2QU, 2FJ, 2AYK, 2LA and three other fellows. 2APT sent in his report via Western Union to make sure it arrived in time. 2AXS says he finally got the DS's QRA from 2AGQ. He is waiting for some filter condensers to arrive so he can have a good DC note. 2AML is now a full-fledged ORS. 2APQ is having all kinds of trouble getting a motor that will turn over his alternator without blowing a row of fuses. 2BOW is trying to reactivate a WE50 that has gone soft. 2AWZ is having lots of trouble keeping his note steady on account of some trouble with his S tubes.

Dist. 3—2SZ will be inactive until about Sept. 15. 2BM is remodeling and expects to be going shortly. 2CHD is installing a 50. 2AXX is a new station in Castleton owned and operated by Rev. F. W. Grunst. 2AGM is still rebuilding. 2CTH is busy with the girls, dances and Boy Scouts so did not find time to pound brass during the past month.

Dist. 4—2AKH is on the air occasionally but does not find much time to handle traffic. 2CYM is overhauling his station so is off for present. 2AGQ is busy these days with farm work and other activities so not much time to handle traffic. 2AMD, Chief Op at ISW, expects to be on the air with a 250 watt during the summer at his home at Catskill. 2AII has resigned his ORS and has joined the U.S. Signal Corps.

Traffic: 2AJE 8, 2AWQ 20, 2AV 8, 2AWX 36, 2ADH 25, 2ASE 21, 2AML 12, 2AAZ 5, 2AAN 2, 2DD 2, 2CTF 1, 2ANV 3, 2AGM 2, 2CDH 3, 2CYH 5, 2AOI 2, 2ANM 16, 2AKH 14, 2AGQ 11, 2WH 17.

NORTHERN NEW JERSEY—2KA has entered the 5th ham stage. 2KS and 2LZ are both off due to landlord QRM. 2GV connected with Aust. after several hard months of trying. 2ALW is a new ORS using a VT14. 2AIM tops the traffic list. 2BW is experimenting with crystal control. 2AUU is a new station in Bayonne. 2BBM is coming back to life again. 2CRP and 2QOI are in business together and are QRW. 2CY, when next heard, will be using a new 100-watt xmitter. 2AZU is a new station in East Orange. 2ANO is busy with YLs. 2ANB has run into hard luck trying to step out. 2AHK graduated from HS and may leave for college shortly. 2BIR rebuilt the station with horrible success. 2JC is going again, due to the kindness of 2CRC. 2AIP has returned after visiting all the active stations in South Jersey. 2CDR has at last built a shart wave transmitter. This was one of the oldest stations on 200. 2CXE has returned from college for the summer. 2CRO is returning to the air after a complete silence of two years. 2CGB is QSO Brazil in day light. 2ADU connected with pIAE. 2AT and 2CJX threaten a strong comeback. 2CP lost his H tube so now is using UX210s. 2QS has a new tube and is heard often. 2CYW has moved to Rahway, N. J. and is using the new call, 2BS. 2DX was accepted for the USNR. 2AEY is off for the summer. 2ATK is still doing remarkable DX work. 2AAW is giving the BCLs a rest. 2AGI worked his first 6 recently. 2BGI is building a portable transmitter for his forthcoming vacation. 2QR is a very consistent worker. 2FR blew all his 5 watters. 2CPD is receiving plenty of QSLs from Africa. 2AER is QRW experimental work. 2AUH is rebuilding and installing a new mast. 2CXY is sporting a new fivver, purchased by selling his ham station. 2AZU just came on with a UX210. Welcome, OM.

Traffic: 2AT 18, 2CP 24, 2CY 15, 2DX 2, 2EY 3, 2GV 15, 2WR 13, 2AHS 35, 2ALW 12, 2AMB 16, 2ANB 16, 2ARC 48, 2BBM 8, 2BIR 4, 2CDR 2, 2CGB 24, 2CPD 2, 2CQZ 26, 2CXE 7, 2CDS 10, 2KA 4, 2AER 5, 2ALM 51, 2AZU 23.

MIDWEST DIVISION

P. H. Quinby, Mgr.

MISSOURI—Traffic dropped badly this month as reporting stations decreased considerably and those operating handled much smaller totals than usual.

Dist. 1—9BEQ leads in traffic and general activity this month. 9ACT and 9DUD come next. 9BHI is doing quite a bit of rag chewing but no traffic reported. 9ZK has been shut down on account of QRN—and what is the Q signal for too darn hot? 9ELY-CFX has been getting out well but not traffic. 9PW fixed up a small battery set.

Dist. 2—9BRU is thinking of selling out. 9DTA moved and had to tear down his set. 9DJ1 has gone to the farm for the summer. 9CKS has returned home from some place which we have forgotten. Hi. 9CYK and 9CKS will have a chance to get busy again while so many others are QRT. 9DIX is QRW from business. 9DNO returned from Washington, D. C. quitting radio as BRS and is now combining with 9DEU. 9RT is busy running a hot dog stand trying to earn enough to buy a jug. 9DAE is QRX learning the works of a defunct Hudson 6. 9DVF moved from Oakwood to 1005 Bird St., Hannibal. 9ARA handled several messages in spite of QRN. 9CVV and 9ARA have a 208A for a new set. 9DKG handled a few msgs but went to Ft. Snelling, Minn. for ROTC. 9LJ handled a good average on 180 meters. 9BSE tried 40 but says all DX is there and returned to 80.

Dist. 4—Independence stations are inactive at this time. Kansas City stations reporting handled few messages, due to hot weather and QRN. 9ACX is still messing with a small 40 meter set and a badly-behaved auto. 9ZD discarded his WE 250 set and built a new set for crystal operation. 9ACA continues his labors to put the KC club on the map with better programs and other activities. 9RR put up a second tower and hopes to have done for good with that kind of thing at last. 9ADR visited the St. Louis gang. 9ELT is QRT for the summer. 9RR got a new job and hopes to be on the air a bit more now.

Traffic: 9BEQ 25, 9AOT 10, 9DUD 6, 9CYK 4, 9AOB 4, 9CDF 3, 9DKG 4, 9ARA 20, 9DVF 2, 9ACA 5, 9ZD 3, 9RR 4, 9LJ 20.

NEW ENGLAND DIVISION

T. F. Cushing, Mgr.

THIS being the last report through the office of the New England Division Manager, I wish to take this opportunity of expressing my appreciation of the many courtesies and fine co-operation given me by the New England Division gang. It has been a great deal of pleasure to have been associated with you as your Division Manager and the many good times and warm friendships made will always be remembered. Please remember that I will always be deeply interested in this wonderful game of amateur radio and glad to hear from each and every one of you.

Let me urge that you give the same loyal support to the new traffic officials, building up a bigger and better NEW ENGLAND DIVISION!!!!!!

RHODE ISLAND—Providence—1BIE is the proud owner of a 204A and works everything he hears. 1AFO makes the BPL this month with a fine total. 1AWE reports good DX this month having worked Australia and New Zealand. 1BCC is going to check out for the summer. 1AID will be off the air for a while due to illness. 1BPB is off for a while. 1AEI is still with us and banging away in fine shape. 1AHE is going on 80 with phone and cw. 1DP is on 40 with a 50 watt but is going to 80 with a 100 watt phone and cw.

Westerly—1CDS requests that he be put on the inactive list for the summer. 1BVV will be closed soon for a complete overhauling. 1AAP is on with his two new transmitters. 1KL is training in the USNR so won't be on much.

Newport—1BQD took unto himself an OW on the 8th of June. Congratulations and good wishes from the gang, OM.

Traffic: 1BIE 7, 1BQD 18, 1AEI 17, 1AAP 5, 1AID 5, 1AWE 18, 1BCC 37, 1BVV 42, 1AFO 109.

VERMONT—The ADM thanks the fellows for the unanimous election to the SCM job and assures you all that he will be at the helm and willing to help on everything pertaining to the ARRL.

Dist. 1—1YD has closed for the summer. 1BEB is sticking at the key. 1BBJ is shooting them along

with schedules FB! Will Prof. Gale, 1BD please QSL 1AJG for his ORS?

Dist. 2—1AJG and 1AC will not be on till Sept. 1CQM will be on at once as home from RPI. 1BIQ is in Montreal. 1APU is OK and QSO. 1FN is on now with a low power tube.

Traffic: 1BEB 10, 1BBJ 26, 1BD 17, 1BDX 12.

EASTERN MASS.—Dist. 1—1LM has walked away with the prize (a VT2) for the biggest traffic total for three consecutive months. He has had a hundred or over each month. 1BMS has schedules and devotes two hours a day to them. 1BZQ has gotten going at his new QRA and reports it the berries for reception, but for transmitting? wait and see. 1CJR is off for Maine.

Dist. 2—1SL relayed a msg from mBX and keeps many schedules. 1BUO is back with the gang after many months at school. 1BVL is QSO many foreigners with 25 watts input. 1ACI still gets out in fine shape. 1AIR is off for the rest of the summer. 1ALP is working good DX. 1RF is getting out as usual. 1BAT is out of school and will be on more. 1AVF is using tuned plate and grid circuit and is getting out FB. 1BCN (broadcaster's nuisance) built a new set. 1ABA gets out ok on low power. 1GA is rebuilding. 1AHV has gone to Bakers Island and will operate 1QZ. 1AEX is getting out OK now. 1AXA has his crystal-controlled set going. 1ADM is getting out in fine shape working several Z's. 1AWB has overhauled his chemical rectifier.

Traffic: 1BCN 6, 1ABA 6, 1AVF 25, 1RF 11, 1AVR 14, 1ALP 3, 1ACI 27, 1YC 27, 1BVL 17, 1BUO 5, 1SL 13, 1ADL 18, 1GA 3, 1ADM 8, 1AXA 5, 1AWB 3, 1AG 12, 1LM 23, 1FF 6, 1BMS 114, 1CJR 37, 1KY 17.

WESTERN MASS.—Dist. 3—1AMZ leads the list but is way below his usual average. 1AAE is spending a lot of time with the YLs but managed to handle some traffic. 1AMS changes his antenna and worked a bunch of foreigners. 1CLN has just started up again with a whale of a note. 1ARE rebuilt, using tuned grid and plate circuit. 1XU has cut a bunch of crystals the past month and promises to supply the local hams gratis. 1BFE is home from school and on with 5 watts. 1CPI is a new station owned by an old spark man.

Dist. 4—1CCP is perking as ever. 1AOF rebuilt his station. 1BOM has moved to Montague, Mass.

Dist. 6—1AAC is planning a low-powered master oscillator set.

Dist. 7—1AAL was QSO Australia. 1BIV has put in a kenotron rectifier. 1GR is waiting for his crystal. 1DB has some traffic with Key West. 1AJK is at last going to shift to 40 meters. 1AKZ has a new flivver. 1AV, an old timer, is back again. 1AJM has been QSO the west coast about 50 times during the last couple of months.

Traffic: 1AAL 10, 1AKZ 6, 1DB 16, 1AJK 2, 1GR 2, 1BIV 24, 1AAE 20, 1ARE 9, 1AMZ 30, 1AMS 9, 1ASU 13.

CONNECTICUT—Your present ADM has been elected for Section Communications Manager and wishes to thank the fellows for their confidence and loyalty in this promotion. It is with pleasure and hope of greater achievement than in the past, the work is resumed. 1SZ has a 204A perking and makes some splash in the ether. 1BHM reports consistent foreign work particularly with South American countries. 1MY has installed a fifty watt in his summer home at Pond Point. 1QV, who lives near the border of our state, says he is going to stay on this side for awhile and help us boost out traffic total. Suppose 1BVB will be after our scalp when he needs Chapman again. 1BGC has greased up the line to Italy again and reports working 1ICO. 1AYR is off to Maine for the summer. 1ADW says the RCA is slow with delivery on a fifty so he is using a fiver to keep on the air. 1IV has been busy helping your ADM to get on the air and incidentally, he is displaying a nice new commercial ticket recently received from the R. I. 1AOX has been having tube trouble and unable to do much relaying. 1CTI is all fixed to operate on 20 meters. 1AOS reports being home from college for the summer and is ready for traffic. 1AVX reports that home duties upset his radio activities but he is working up a 40 meter set. 1FD reports being under the weather and unable to do much operating. 1ZL has returned from Wesleyan and after shinning up the old set, he hooked up with Canadian 4DT at Manitoba. 1VY reports the Stamford boys are enthusiastic and your ADM hopes to reward some of them with an ORS if the work continues.

Traffic: 1SZ 34, 1BHM 24, 1MY 23, 1QV 14, 1BGC 7, 1AYR 6, 1ADW 5, 1IV 5, 1AOX 3, 1VY 4, 1PE 15, 1ABN 9, 1BQG 8, 1CJX 44, 1BZQ 35, 1BLF 6.

MAINE—The ADM has been evesdropping this month. This was sort of a fault finding expedition between 10 and 200 meters. I admit freely that I was looking for anything wrong, and making a log of each and every transgressor. The details are unnecessary to recite here, but the summary is interesting. The observations apply wholly to Maine stations. There is almost no operating outside the bands. CQing has gone out of style as a pastime and when you hear a Maine station CQ, you may be sure that he has something to get off his chest. The brand of operating has improved wonderfully in the last few months. Those stations who are on regularly sound almost commercial in their proficiency. It is entirely natural that station activity should drop off at this time of the year. Let's keep in touch with the game, fellows.

1EF reports being very busy. 1BI, 1AAV and 1AUF make the BPL this month. 1AUC, 1BDB and 1ATV reported but no activity.

Traffic: 1AAV 145, 1AUF 140, 1BIG 420, 1ADI 7, 1BNL 13, 1QY 23, 1AUC 2, 1BDB 2, 1ATV 71.

NEW HAMPSHIRE—1ATJ is QRW selling gas to the motoring public. His hours are from 6:30 am to 6:30 pm so not much time for radio.

Traffic: 1ATJ 6.

NORTHWESTERN DIVISION Everett Kick, Mgr.

THIS report marks the passing of the old form making DM, ADM, DS and CM obsolete. The DM wishes to express to the gang his thanks for their co-operation. QSU and vy 73—u7EK.

WASHINGTON—Activities are low although many stations are carrying on. Many of the gang are working. 7BW-7AFN went over the hundred mark but failed to designate Orig., Del., etc. 7BB is rebuilding. 7AFO is consistent. 7AF and 7CY have H tubes perking. 7AG, 7PZ and 7ABF are rebuilding. 7VL has more power now. 7NS and 7AF operate portable 7ABO. 7ABX is pre-CW 7NL. 7OT will take unto himself an OW while in the East and says he may sign 9???? 7AY is looking for a BP job. 7BU is back from the Wilkins Expedition. 7HO is operating 7SC in Alaska. 7AB is reported doing good DX but too modest to report. 7DF spends most of his time working so has little time for radio. 7AIM is said to be preparing for the Vancouver, B. C. Convention. 7GB finds time to do a little work. 7WQ is building a new shack. 7GR was last heard near Panama. 7TK works A, Z, P, I, and Js with ease. He is breaking two YLs into the game. 7NH and 7AAB did well in the Aussie Two Way Tests. 7EK is now at his summer QRA. 7MZ is back for the summer. 7MP is doing fair work. 7VN decided to quit the ham game. 7GE was in a very bad accident but is recovering rapidly. 7FD thanks the gang for their help and co-operation. He has been appointed SCM pro tem. The new SCM will be elected shortly. Nominate and vote for your favorite, OMs.

Traffic: 7BW-7AFN 102, 7BB 92, 7AFO 75, 7AIM 25, 7DF 23, 7VL 20, 7AF 18, 7OT 16, 7WQ 12, 7NS 8, 7OY 7, 7NH 6, 7ABX 4, 7GB 4, 7VN 7, 7MP 2, 7EK 62.

OREGON—7IT says he cannot accept the SCM nomination for lack of time. 7TM worked oASE at last. He and his brother, 7VH put 450 watts into a 50 watt and got 4 amps antenna current. 7WU has been doing good work in the traffic line. 7LQ is moving to Berkeley, California. 7IT is on again after several months inactivity. 7AV is going strong on a UX210. 7DO, KGW's announcer, has found time to pound brass between announcements. 7UT is a new Portland station. 7JC worked BAM and a Zeeder on a UX210. 7KY worked Japan and got an R7 report. 7ALK is tuned up and going strong. 7AEK is doing fine QSR work. 7EO is on occasionally.

Traffic: 7AEK 45, 7WU 42, 7AV 8, 7EO 2, 7IT 1.

IDAHO—7JF has been doing some fine work with Hawaii. He is now in training at Camp Lewis, Wash.

MONTANA—7PU still holds the top notch in this state. 7DD uses the 40-and 80-meter bands. 7NT has just finished some test equipment for BCL sets. 7ZU is going East for the summer University course. 7AGF is QRW with his Electric Shop. 7FL has

graduated and is going to Bozeman in the fall. 7APF is moving and is getting back on the air. He also helped 7AAT get started on 40 meters. 7ACI is going to do patrol work for the Forestry Dept. this summer. 7EL is trying to get time to get back on the air.

Traffic: 7PU 76, 7DD 8, 7NT 2, 7AGF 1.

PACIFIC DIVISION L. E. Smith, Mgr. So. Section

SUMMER is here, but activity has taken no great drop. We used to think it was necessary to have a summer slump on 200 meters but there's not the least excuse for it on our short waves of today.

Dist. 1—6BQ leads the entire section with traffic. A new crystal-control outfit will soon be on at 6BAS. 6SB was QSO picD8. We are surely sorry to lose 6AJM. He was one of our most consistent traffic and DX men and will be missed. 6OHX keeps a sched with 6AEN. The YLs got 6CGG.

Dist. 2—Several of the gang are going to the C.M.T.C., some to sea, and others on vacations, but one listen on 40 meters is enough to show that Dist. 2 is still going strong. 6BJX has been on his vacation. 6DAJ is getting a 50 watter as a graduation present. 6AKX sez he has the Hertz fever??? 6DAA sold out forever. 6CGK was QSO KFUH. 6CAE was QSO NEM, the USS Denver at Arica, Chile. 6CND ops at KSMR. 6BGC works A Z & Di every AM. 6BBV keeps in touch with his boss in Oakland every noon by radio. 6DAH got a commercial ticket. 6ICW was stricken with malaria but is better now. A Grebe CR18 drags 'em in at 6CAH. 6RF uses an advance sync now with great success. 6AKW is making harvest. 6CSW is home from a trip to N. Y. 6ZBE is doing fine with his 250 watter. 6BVO is doing his best with a new 50. 6ANQ works fine DX on a 7.5 watter. 6DDO, a new ORS, uses a WE 50. 6BDX worked oSR and rFF9. 6NW came within 2% of getting a perfect grade on his commercial ticket. 6NP will soon be an ORS. He handled traffic with NZ and with the Convention at Denver for the Rotary Club. 6BUR has been experimenting on 20 meters but finds things rather dead. 6KY and Portable 6XBR are doing fine work.

Dist. 3—Things are getting organized now in this district and much more activity is shown. 6BAV handled technical msgs to the Lick Observatory from Santiago, Chile. 6ZBJ is putting Santa Barbara on the air again. Glad to see you back, OM. 6ASV complains of no traffic. 6AKZ is experimenting with a portable outfit. 6ALR is using a UX210.

ARIZONA—6ANO is home again and promises to run up a traffic total that is noticeable. 6AZM is using a 201A with B batts. 6XAW is using fone on 40 meters and doing good work. 6CUW handled a good lot of traffic. 6BVD is going good with a 50. 6ANO has but 10 watts but sure gets out and handles the traffic. 6BJF has decided to quit monkeying with his set at last. 6BBH is using a portable with 90 V of B. 6DCQ is sure doing great. During the Aussie tests, he worked up to 4 Aussies every morning, got R6 reports and he uses only a 7.5 watter. 6RWS is still doing low power work. 6CLZ worked hu6OA and pl's and A's. He is not working properly yet.

Traffic: 6XBR 85, 6BAS 6, 6AJM 153, 6SB 24, 6RQ 223, 6CHX 8, 6CGC 5, 6DCK 31, 6ZBJ 7, 6BAV 15, 6ALR 22, 6AKZ 1, 6ASV 3, 6DCQ 17, 6CUW 53, 6XAW 10, 6AZV 30, 6ANO 55, 6BJF 5, 6BWS 2, 6BXD 52, 6BBV 51, 6IH 20, 6DAI 19, 6BGC 23, 6BJX 12, 6DDO 29, 6CSW 7, 6BGV 18, 6AKW 3, 6RF 7, 6CAH 5, 6BVO 27, 6OF 9, 6AJI 6, 6ZBE 13, 6ANQ 14, 6DAJ 5, 6AKX 4, 6CGK 3, 6NW 3, 6NP 108, 6CQA 29, 6BUR 19, 6KY 177, 6CLZ 53.

NORTHERN CALIFORNIA P. W. Dann, Manager

6RVY has schedules with pilAU, hu6AXW and u6KY. 6OLP slowed down during the month. 6CJD is QRW at University of California. 6CIS wants schedules with 9's and 6's for daylight work. 6NX and 6CKV received and transmitted the 500 word test messages with Australia. 6APS shot his 500 word message to Australia but could not get one back. 6AMM is the most consistent station in the District. 6CSX is out of the running this month with a burnt 50. 6AJZ is QRW school work. 6BMW is QSO Mexico, Cuba, South America, NZ, Aust., Alaska. 6ALW is rebuilding his entire set this month. 6CEI is still very QRW. 6HC came on the air with 1000 volts of dry batteries. 6DDO operates most every evening on 40 meters, handled most of his traffic with hu6BUC

and 60A. He also worked a2TM. 6BAF will be on 20 meters soon. 6BAK is a new ham.

Traffic: 6OC 70, 6CLP 13, 6CIS 3, 6CJD 3, 6BVY 74, 6NX 11, 6AMM 71, 6CSX 14, 6AJZ 1, 6BMW 26, 6ALW 2, 6DEK 7.

HAWAIIAN SECTION K. A. Cantin, Manager

The arranging of schedules, routing traffic to reliable stations and making "air friends" via radio are some of the reasons why local stations have improved message delivery to the mainland. Numerous stations from the first to the ninth district are accepting and originating traffic for Hawaii and it appears that stations also realize that we will relay to different points bordering on the Pacific. 6AXW again heads the traffic total for the month. Numerous schedules were kept with different stations. 6BDL turned in a good traffic total. 6BUC continues to lack operators to pound brass and at present have but three on the job. 60A has been kept busy originating and delivering traffic. 6CFN was on the air for part of the month. 6CFQ overworked his transmitting tube with traffic work, hence another tube has "gone West". 6CLJ has helped 6ADH, 6AKP and 6ACG break into the game. 6CLJ will be off the air as he is making a trip to the Orient but plans to have another ham operate his station during his absence. 6DBL's 250 watter went dead and is using 50 watts until he can raise the cash for a new one. 6ASR is back on the air with a 250 watter and starting to handle traffic. 6TQ is gradually building up a traffic schedule with the 6th district. 6CST also had the distressing event of having his transmitting tube go dead. 6NL has installed a 50-watt set. 6AJL is installing an H tube and a new copper tube antenna. 6BUS is a new ARRL station to hit the air. 6CMH does not go in for traffic work and is experimenting with different types of transmitters. 6DCF is QSO all districts in U. S. Hu-6AFF's transmitter is still under construction.

Traffic: 6AXW 206, 6BUC 177, 6BDL 153, 60A 103, 6CFN 39, 6CFQ 85, 6TQ 35, 6ASR 30, 6CLJ 23, 6DBL 17, 6CST 7, 6NL 6.

ROANOKE DIVISION W. T. Gravelly, Mgr.

WEST VIRGINIA—The general report for the state is slightly better in DX schedules kept, improvement, traffic slightly under normal. 8AUL worked bo2, bz5ab, f8nx, f8cs and q2xy. 8CDV worked ilo and bz5ab. 8SV reports having schedules with A and Z stations. 8AWW had 28 feet blown off his 70 footer during a wind storm. 8CYR is contemplating higher power. 8BJG is alternate Army station. 8API is principal. 8SP is on a vacation to Yellowstone. 8BNF is on again. 8BXP is off until school opens. 8BJG worked a5BG with 7.5 watts input. 8ALG is stepping out with usual DX. 8AMD worked WNP. 8SV used a 250 watter, worked P.I. 8APY again leads in W. Va. traffic reporting. 8CBR is very active receiving numerous DX reports. 8BSU has new call, 8QY, instead of 8AKZ. 8CFK is a new ORS in Wheeling. 8BSU is principal Army-Amateur station in Wheeling.

Traffic: 8AYP 207, 8AMD 21, 8CBR 15, 8SV 13, 8BJG 3, 8AWW 7, 8CDV 3, 8AUL 6.

NORTH CAROLINA—4JR says the district has gone to the bow wows.

Dist. 2—4VQ started a message around the world and it went.

Dist. 3—4BX is still going good on 40. 4PR is a new station in Charlotte and is doing fine with a 50. 4NH is working DX enough for a 250 watter with his 201A. 4QK changes over to a single wire antenna. 4JR is still sticking on the air with good all around results.

Traffic: 4VQ 11, 4PR 5, 4BX 10, 4JR 21.

VIRGINIA—It is my sad duty to inform you of the death of an old timer, Mr. Overstreet, 3BKX, who died June 24th after a brief illness of only a few days. All the hams in this Division seem to be very much excited over the faint prospects of holding a convention at Richmond. We feel sure that with the proper support the thing can be pulled off and we are assured that several of the gang from Hartford will come down and help chew the sock.

3MK is planning to change to a Hertz. 3CKA is working a few hams. 3SB is back on the air with a fiveer. 3CKK is building a new shack. 3TI can't work south for some reason. 3AUU and 3AOT are solely relying on the outcome of a joint station; until then their renewed interest is questioned. 3ABS is at school in Angola, Ind. 3BMN cut out tennis and

BCL and fired up the old 50 and chews the fat with the gang daily. 3CEL is Chairman of the Richmond Club and 3AAJ is Secretary and Treas. 3IW is on 40 and 80 meters now. 3AAI is on every night and reaching out with the new crystal-controlled set. He has offered the use of his station to the American Legion state convention being held in Alexandria in August. 3BGS gets several days a week at the set and Saturday night reaches out FB on 40 meters. 3KG has no luck with B-battery supply, so thinks he will try spark-coil cw. 3RDZ has not had time to do any work for the last few weeks. 3CKL is on the air some. 3BZ is heard chewing the rag often. 3CA held a regular old timer rag chewing contest with 2ZE.

Traffic: 3CKA 12, 3TI 2, 3BMN 39, 3CA 14.

ROCKY MOUNTAIN DIVISION N. R. Hood, Mgr.

COLORADO—Please send all monthly Colorado reports direct to 9CAA, 1641 Albion St., Denver. This is in accordance with instructions from Hartford and will continue until such time as an SCM is elected.

Denver—9CAA has a new job now with the telephone company and so doesn't get on the air as much as formerly. 9EAM sells gas to the flivvering public and so doesn't have much time on the air. 9DQG is back on the air again. He has skeds with 6CQA to handle traffic for 6CQA'S dad but the sked fell through as 9DQG couldn't seem to hook. 9BYN got a lot of traffic for 6CQA, Sr. however, so all's well. 8AX was a guest of the Denver gang one evening and left a couple of prizes to be given out to ops here for the best work done. 9CAW is working everything in sight now on 40. 9DKM has been hooking up with Australia the last few nights. 9DED reports no traffic but looks like he might have some now that school is over. 9CJY has gotten back on the air and put through a couple before time to hand in the reports. 9QL is working on a crystal-controlled station.

Dist. 1—9DVL has been very busy getting through school. 9AOI wasn't able to be on very much either but he did a little.

Dist. 2—It is with deep regret that we have to announce the resignation of 9ADI as ORS. 9DFH has closed his station for the summer. 9BUG'S ORS is hereby cancelled for failure to report. Sorry, OM, but rules is rules. 9EHP is a new station at Trinidad. 9FE is back at Trinidad, also, and needless to say, 9EAE is still holding his own with them. 9CHD, the new station, is doing good work.

Traffic: 9CAA 55, 9RIN 30, 9DKM 30, 9CAW 11, 9CJY 2, 9EAM 16, 9EAE 33, 9ADI 42, 9CHD 2, 9CDE 10, 9AOI 11.

UTAH—Dist. 1—6CJB is away on a trip to Montana. 6CVA has just received his ORS and is very active, although only a few messages were handled. It is operated by Clarence Smith of Bountiful, who is on until the break of dawn nearly every night. 6FM has spent most of his time in Pocatello lately and handled only a few messages. He reports 6AIK as a new station in Ogden. 6CQL is in Aberdeen, Idaho. 6CSD is visiting in the East. 6RM is in Riveside, Calif. 6CRR and 6CRS are still here but working on new equipment for their sets and no traffic handled. 6ZT left July 1st to visit Denver and other cities in that territory.

Traffic: 6CVA 5, 6FM 9.

SOUTHEASTERN DIVISION A. D. Trum, Mgr.

THIS being my last report as DM, I want to express to the Division my heartiest appreciation for its splendid co-operation and support. Our correspondence has been the source of much inspiration of fellowship and I hope that those outside of my territory as SCM for Alabama as well as those under my jurisdiction, will continue their rag-chewing via mail with me. ORS failing to report for the next two months will be cancelled. Florida is coming into her own by the hard work of Grogan. About time some of you fellows sent in a nominating petition for him.

ALABAMA—5VV left the city on a vacation and forgot the report. 5AWF is bursting through the ether FB, while 5AX has the prettiest DC note around this part of the country. Quite a few new hams are starting up in Birmingham and soon they will get into the game good. We will hear more from them. 5AWF has been over to 5MI trying to filter the

sine and he sez its possible. 5DL works most everywhere. KOMQ and KDKL have been visitors out to his shack and give the hams the fits with commercial brass-pounding. 5LC is still going it and doing his stuff. 5AR is losing interest—'smatter, OM? 5QF is off for a while but will return soon. Dist. 3 is placing its bit of notoriety over the seas. 5ATP has worked his 21st country. 5ADA says its due to the transformer he built 5ATP. 5AFS started out to get a pure DC note or bust in trying and he didn't bust. Hi. 5AJP remodeled and is doing good work, when he gets away from WIBZ, which he is just getting into good shape. Dist. 4 boasts of two new good hams, 5AHU and 5AGA, who also work 5YB at the college. 5AHU at 5YB, did quite some message handling this month.

Traffic: 5ADA 33, 5AJP 19, 5ATP 27, 5AWF 15, 5DL 23, 5AX 40, 5YB 90.

PORTO RICO—Honors for traffic handling during the month go to pr4KT, who, undoubtedly, is doing a great deal to boost the A.R.R.L. service. 4UR takes second place in spite of the great handicap that bears upon him—the ever-going arc of the naval station, NAU, which is usually 24 hours on the air. 4SA has taken French leave for a while and will be a visitor at the Second District's Convention. 4JE keeps his regular hours and is doing most of the foreign traffic handling. 4BJ has been inactive during the month.

Traffic: 4KT 179, 4UR 42, 4JE 28.

SOUTH CAROLINA—4MV is a real hustling station, who is on regularly and has schedules with 4OB and 3BWT. 4IT is an A-A station, now. The weather was too warm down in the "Sunny South" for 4OY so he's spending his vacation up in New Jersey. 4AAM hasn't missed reporting yet. The Light Company mused up 4RR's location and he is now trying to remedy the trouble.

Traffic: 4MV 159, 4IT 17, 4AAM 11, 4RR 15.

GEORGIA—4RM has returned from Florida and is back on the air. 4SI worked Portugal. 4KU is on low power. 4BZ is back after a year's absence. The Georgia Tech Radio Club is off the air until next summer school opens. There is still room for a few more A-A affiliations.

FLORIDA—4HY worked g6YD and g2QB. 4FS is Consulting Operator at WJAX, the municipal broadcast station. 4MH, a newcomer, is waiting for a sync rectifier. 4UX is on the air now and then. 4UK is heard every Sunday working all kinds of DX. 4PK has a new 250 watter. 4DU has a new location and has not had time to set up his junk yet. 4TI operates the Seager Radio Co. 4OB has another H tube. 4TK hits the hay early and gets up in the wee sma' hours trying to DX and he does it, too. 4OB and 4TK operate in the famous Atlantic relay line, noted in the June issue. 4OB handles traffic like a veteran and in fact, hangs around the key at all hours hunting and clearing DX traffic. 4CJ started out with a 7.5 watter but put it on the bum along with 2 UV202's. 4CE is temporarily on the bum with two fivers having melted the plates. 4IG burnt out his armature on his motor generator and has just received another. 4AAO is doing excellent work and handling traffic in good shape. 4QY blew his tube. 4TY is so busy with his work he didn't have much time to pound brass. 4UA has been inactive but hopes to be on soon. 4BL is rampting around and sent his report for part of the month from Wisconsin. 4HX is rebuilding. 4TR is back on the air and is working 'em right and left, using remote control.

Traffic: 4TK 9, 4TR 39, 4OB 45, 4VS 54, 4AAO 23, 4HX 17, 4QY 11.

WEST GULF DIVISION F. M. Corlett, Mgr.

AS your retiring DM, I wish to express my appreciation for the excellent support and co-operation of my assistants. The fact that you have elected in most instances, your former ADMs, is proof that you, too, appreciate their efforts. Relieved of the duties of DM, I can serve you more efficiently as Director and representative. I invite your comments on League policy for the remainder of my term. All pending applications for ORS appointments will be forwarded to your new SCM who will act upon them. "30."

NORTHERN TEXAS—The summer slump has hit this section but the same old bunch of reliable stations are in action. 5NW, 5VU, 5JF, 5HY, 5AKN and 5ALC have done consistent DX and handled im-

portant international traffic. 5JF is a member of the "Worked All Continents" club. 5AKN has three reliable wavemeters and can give accurate information to the gang.

5ACL is active on 20 meters. He QSO's 1's and 2's at noon daily. 5SH says the Cats may "come back." FB, OM. Can't you get the rest of the felines to show some pep? 5CC, 5SP and 4AJT are temporarily off for repairs and otherwise.

Traffic: 5NW 10, 5VU 5, 5JF 4, 5HY 12, 5AKN 12, 5ACL 5, 5SH 16.

SOUTHERN TEXAS—The gang is on the job. 5HS is on 41 meters. 5AMP has been heard by g's, a's, ch's and Honduras. 5OX is back on the air and will have two or three ops later. FB, OM. 5EW has a five hundred wattage going with an MG plate supply. OM Sahm is about to go back on again. He has just received his BA degree from Texas U. and now has more time. 5ANA has been in poor health so did not do much. 5QI is not active at present. 5HW has a 7.5 wattage on 20 meters. He wants schedules day or night with anyone.

Traffic: 5EW 1, 5OX 10, 5HS 1.

OKLAHOMA—5ADO worked foreigners in three weeks—blew his UX210 and now plans a raid into the 9th district. It's too hot in the garage for 5ABO (he weighs 210 lbs) and the O. L. won't let him have the transmitter in the house. 5ANL is on a vacation. 5APQ is getting 5WD lined up. 5AGN and 5AAV are flivvering to Calif. 5AQT is working foreign DX. 5ATV traded his 50 wattage for a radio course and we expect a new "Y" call in Oklahoma City soon. 5ATK is still QRW the ladies. 5APG now has a commission as Ensign C-V (S)USNR. He had a pleasant visit with 5ZC and saw some of the rest of the Dallas gang. 5GJ is also threatening to join. 5TW kept skeeds with 22 different stations the past month, using a new 50 wattage, 40-meter transmitter. (Please note traffic total for results—FB) 5TW is Army Net station and also belongs to the Naval Reserve. 5AJM is teaching his YL the code. 5AGO is building a portable to take to school at Roswell, N. M. 5TW's experience proves schedules practicable. The result speaks for itself.

Traffic: 5SW 11, 5ADE 22, 5AAV 20, 5APG 13, 5APQ 7, 5ANL 13, 5ABO 8, 5ADO 8, 5TW 413.

CANADA

VAN-ALTA DIVISION A. H. Asmussen, Manager

DX conditions are improving on 40 meters as it did last spring and summer but the traffic totals and the monthly reports are poor. 5AS's message total suffered from the fact of losing his mast in a recent storm. 5HP is operating 5CR's pile of junk for the summer. 5CR hung up some good DX to shoot at before he left, having worked R. HU and BZ. 5GO is out at camp with a 203A working on the seventh harmonic and getting out FB. 5GT worked an Aussie but doesn't seem to get much of a kick out of DX. 5AM is also getting out FB and 5BM can be heard occasionally. 5GT expects to have a real HE transmitter by fall.

The Alberta Hams had a get-together meeting in Calgary on May 23rd and 24th. The AREA gang in Edmonton have novel QSL cards for all stations that are QSO them. 4HF is trying to get QSO with the DX he now hears. 4AH pulls the switch promptly at 9:15 each night. 4CS has no power supply other than batteries. 4AP has been trying the 20 meter stuff but handles his traffic on 40 and 80. 4AL won the Jewel prize for this district. 4DQ can be heard every day at most any time after the dishes are washed. 4CC is a new ORS and on the air consistently. 4GT is trying to raise G-5QV on schedule but gets all his OSL cards on this transmission from the Aussies. 4IO had a sniff on 40 and grabbed off a few messages but doesn't like to dismantle his 80 meter pet.

Traffic: 5AS 5, 5CR 11, 4AF 9, 4DQ 4, 4GT 7, 4IO 7.

PRAIRIE DIVISION F. E. Rutland, Mgr.

MANITOBA—Summer activity is keeping up in good style with most of the gang turning in good traffic reports. 4DT is the most consistent station at present. 4DY has a new Schnell tuner using 4DF's famous S/W coils. 4DF gets best reports from his MG set when its turning out a punk AC growl. 4AW is using a 210 and reports good DX. 4BK is second op at 4AWS. Ex4AG is back on the

air using 2101A's. 4BT reports fair traffic and good DX. 4DW is still working from 20 to 80 meters. 4DU has a terrific kick on 40. 4AE is in the East for the summer. 4DE is rebuilding.

SASKATCHEWAN—4RF is on a business trip to Montreal and other Eastern points. 4CP is acting ADM. 4AO is on occasionally and is building a 250 watt set. 4CP is using a 112 and is building a MG to handle 500 wattage. 4CB is using a lone fiver and contemplates a MG of some hefty B's. 4AQ still gets good DX with a 201A plus 200 volts. 4AC is QSO states on 'phone at 170 meters. 4HS has changed his location and now gets out FB. 4IH has not done very much as yet. 4HH is going strong with his new 250. 4BL is taking post graduate work at University of Iowa and has a regular schedule with 44C.

Traffic: 4BT 25, 4DF 13, 4DU 5, 4DT 17, 4DW 11, 4DY 15, 4AO 4, 4HH 22, 4AC 19.

MARITIME DIVISION Wm. C. Borrett, Manager

NOVA SCOTIA—1ED reports having worked French, Italian and British stations this month. 1AR reports that contact with New Zealand and Australia was easy during the recent tests. 1DJ is working on a series of talks on ARRL and ham radio to be given out over CHNS, Halifax, where 1DD officiates twice a week. 1DD has been sick but is better now and ready to QSO anywhere. 1DM and 1CX are on the air regularly. 1DQ is still suffering from tube shortage. The Nova Scotia gang are wondering what the NB gang did to 1DD to put him on the blink so completely after he returned from that never-to-be-forgotten convention. 1AC is back home and rebuilding. He reports a new ham station there, 1BE. We understand that ex1BV is spreading fame among the Ontario gang. 1BZ works 65JX often.

Traffic: 1DM 2, 1CX 1, 1ED 6, 1BZ 2.

NEW BRUNSWICK SECTION—1AM reports working west coast on 20 meters at noon and getting R6 on his sigs. 1AF is experimenting on five meters and low power stuff and reports working 1MD. 1AQ lost his pole and five wattage and is looking for another storm to come along and bring them back to life again. 1AN has fixed up a radio beacon so when he goes fishing he can always find his way back home again. 1AX, a new station in Fredericton, has just opened up. 1AK and 1EI are building a portable transmitter and receiver and plan a tour of the province soon, visiting all the stations.

Traffic: 1AI 29, 1AM 7, 1AN 3, 1AK 11, 1EI 8.

ONTARIO DIVISION W. Y. Sloan, Manager

WORD comes from 3NI that the Northern District is closing up shop for the summer. The News Bureau in Ontario has been working hard. More than 185 inches of local news was printed in Toronto, Ottawa and Niagara Falls newspapers and Radio News of Canada carried a page. The publicity gang is right on the job.

EASTERN DISTRICT—3IU is taking a trip to England this summer carrying a short-wave receiver to keep in touch with the gang. 3GJ reports working France with a fiver. 3JW continues to add to his list of foreign DX. After two nights of poor reception and weak signals, 3CC investigated and found that lightning had used his aerial as a path to earth, burning off several connections on his receiver. 3AFP still finds time for brass pounding.

SOUTHERN DISTRICT—A real ham club is reported to be flourishing in London with lots of new material in sight. 3GY uses 40 meters for reception. 3CM and 3ADM are coming on soon, the latter using S tubes. 3XN refuses to desert 180 and his fone. 3ADY worked the coast on 180 meters. 3ACO is getting all ready for a quart bottle in the fall and is now playing around with different receivers. 3ABG is considering changing his QRA. 3IA is all set for a new St. Thomas station. 3FU has left for a trip through the Western states but has made arrangements with 8DBJ to report the arrival and departure of Erie Yacht Club boats and the passenger steamer between Pt. Dover and Erie, Pa., every day this summer. FB, OM! 3DH wins the prize for the best operated station in St. Catharines. He is sticking to 80 and 3MF to 40 and both are doing consistent work. 3KA is building a "super-accurate" wavemeter. 3KP opens his summer season by working a2VI for 8/4 hour sending single both ways and no QTA. 3BQ, 1BV and 3NF are all in St. Kits for the summer. 3AQ shot both his transformers and is off

indefinitely. 3ZB fools with different antennas and pushes his 203A to the limit.

CENTRAL DISTRICT—3CC and 3CR are going well, the latter doing good work with 90 volts on a peanut tube. Gowan reports from Kitchener that he is trying out a 39-meter Pickard-Geggerow antenna with 60 watts input. 3FC is still pounding away but the message total has slumped due to the breakdown of his schedule with 8N1. 3FC wins the Central District traffic shield again for his excellent work with a 7DX during the reliability tests with Australia. 9AL is moving all his gear to the top floor, but manages to lead the division in traffic totals. 3MV is busy plugging away between work hours; and 3EL, who is retubing, will be on again when school QRM is over. 3BE likewise complains of exams but is fitting out a portable set equipped with dynamotor to carry camping this summer. 3AZ would like to fix up schedules both east and west. 3CK is handicapped by the loss of the second op, who is on the lake boats for the summer. 9AG is another victim of the summer slump. He is keeping 9BJ on the air with a low-power set at summer quarters.

Traffic: 3KT 9, 3GJ 6, 3AFP 3, 9CC 5, 3JW 2, 3DH 7, 3FU 2, 9AL 18, 3FC 17, 3BR 4, 3AZ 4, 3CK 1.

QUEBEC DIVISION Alex. Reid, Manager

2AX and 2BE have worked at least 25 foreign stations in 15 days. 2DO reports that 2BB has started up and is doing some real DX. There will also be three other new calls on the air before fall. 2HT and 2EV are doing good work with fone on 175 meters. 2BE has also dug up his old fone set and chews the rag with the gang on Sunday mornings. Time to ham work. We sure miss his fist on the air. Understand the Canadian Government is sending the S.S. Boethic North this year in place of the Arctic. Watch out for her as she will be equipped with an up-to-date short-wave transmitter and will probably 2AX had a call from 3 Ottawa hams also c4BF and u2WC of crystal fame visited some of the local stations and left some valuable information with them.

Sorry to hear that 2CG has been unable to give any work hams. 2BG is now making early morning calls on his friends.

OFFICIAL BROADCASTING STATIONS

Call	Changes and Additions			Days of transmission
	Local Standard Time			
	7:00 pm	10:30 pm	12:30 pm	
1BFT	—	39	39	Sat. Sun.
1BFT****	—	—	—	Thurs. Fri. Sat.
2PF**	—	—	—	—
5ADA	—	37.5	—	Daily
6BJX*	—	—	—	—
6BUC*****	—	—	—	Wed. and Fri.
8EQ***	—	—	—	—

- *6 pm daily except Sundays, 40 meters.
- **6 pm Mon. and 10 pm Thurs.—39.4 meters.
- ***8 pm, 37.5 meters—Tues. and Fri.
- ****6 pm, 39 meters.
- *****9 pm, 40 meters.

AMATEUR RADIO STATIONS

(Continued from Page 45)

watts the normal antenna current is 0.8 ampere operating on 38.6 meters. Since the crystal control has been put in at 1AXA Pierce says that his DX has increased fully fifty percent. Reports from Australia and New Zealand regularly say that 1AXA is R-7. 1AXA has been QSO a number of Australian and New Zealand stations as well as a large number of Europeans.

EXPERIMENTERS' SECTION

(Continued from Page 42)

The sensitivity of this device is naturally low but amplifiers can be added if proper care is taken in laying out the wiring. A proper scheme is shown in the article referred to. If static is being observed in the lower Mississippi valley the present writer is quite certain that no amplifiers will be needed.

—R. S. K.

CONVENTION SUCCESS

(Continued from Page 40)

from WCCO. Two weeks previous to this, a Twin City Radio Club program was broadcast by KFMT. On the last day of the Convention, a Constellation (Kangaroo) Court was being held at the Radio Show, and most of the notables who attended the A.R.R.L. Convention were arrested and accused of various things, such as stealing vacuum, flirting with Eskimos, or spoiling the isolation of the United States by working too many foreign countries.

8. The Radio Show, which occurred in town at the same time, picked Thanksgiving week because of the fact that the A. R. L. Convention was to be here that week, and the Convention had been widely advertised, so correlation between the two became complete.

ANOTHER MYSTERY

(Continued from Page 38)

gether. That set me to thinking—I included a coil in my "absorption" circuit and connected a key across the whole business (see Fig. 3). Now, when I tune my coil, L, in resonance with this receiver I can extract energy in the usual manner and his receiver stops oscillating. But when the coil and key are shorted by a key (shown in the circuit) my antenna is not in tune with his and again his set starts to oscillate merrily. It is only necessary, then to work the key up and down in the usual manner to carry on intelligent conversation. In a similar fashion a microphone may be connected to the "B" antenna and voice transmission secured. I have found this thing to work niftily with the antenna up to twenty feet apart and if it does nothing else, it does prove that antennae should not be run parallel in congested neighborhoods.

I am going to continue testing it. But remember that such an "Absorber", though it does not radiate energy, may cause QRM and therefore a license is required even to work this kind of "sending" apparatus.

First we heard about low powered transmitters—now here we are able to talk with no transmitter. Hi!

1—That brings up a delicate point. Who requires the license—the fellow with key or the fellow with the "blooping" receiver? We are inclined to think it is the fellow with the receiver.—Editor.

Correspondence

The Publishers of QST assume no responsibility for statements made herein by correspondents



Ham Co-operation

Seattle, Washington.

Mr. K. W. Weingarten, Director,
American Radio Relay League,
3219 N. 24th Street,
Tacoma, Washington.

Dear Sir:—

This office wishes to congratulate the members of The American Radio Relay League for doing such good work in Tacoma in assisting Broadcast Listeners in locating and eliminating interference. I am enclosing a copy of a letter received from a broadcast listener in Tacoma this day, for your information and for the information of all other members of the American Radio Relay League.—*O. R. Redfern, U. S. Supervisor of Radio, Seventh Radio District.*

The Letter

1702 South 52nd Street,
Tacoma, Washington.

Mr. O. R. Redfern.

Dear Sir:—

I have just had some information from a member of the A.R.R.L. which explains much of the local interference. It has been mostly telegraph sending from Japanese ships. It is rather odd they should get into the broadcast band. I think I can understand some of your handicaps, especially after the judge's decision in the Zenith case.

Mr. Hoover is going to find a very wide gap between the integrity and sportsmanship of the amateurs and the greed of the professionals.

As a broadcast listener would you mind extending thanks for me to members of the A.R.R.L. who have helped to reduce interference?

—*Claude H. Annis*

He's Right

7929 Harvard Avenue,
Chicago, Illinois.

Dear Eddie:—

I read with considerable interest the article in the June issue of *QST* on the Taurenwerfer Beam, as it recalls to memory a series of stupendous experiments which I made in the summer of 1893 when I was Director-General of Railways on the Island of Yap. As such I also had charge of the radio telegraph stations.

I hesitate to accuse such an eminent

scientist as Dr. Taurenwerfer of plagiarism, particularly in the columns of *QST*, yet in view of the facts, how can I do otherwise? If you will refer to my paper on the *Guiding Influence of Sunbeams*, read before the Radio Engineers' Club of the Island of Yap and published in the October 1893 number of the Proceedings of that Society, you will note that it strangely resembles Dr. Taurenwerfer's article. It is true, Dr. Taurenwerfer has substituted an arc light where I used the light of the sun itself, but that, no doubt, is due to his inability to construct my Heliocurvator (Patent No. A-349687 August 1893), a mechanico-optical device for bending sunbeams. It is of no importance but incidentally, in the course of these experiments I determined the tensile strength of a sunbeam. It was necessary for me to do this in order to apply the proper bending forces. However, this is aside from the point. My purpose in writing this letter is to direct attention to a grave error in Dr. Taurenwerfer's theory of what he modestly calls the Taurenwerfer Beam.

He claims, giving as substantiation Newman's *Lead Kindly Light*, that when the radio wave reaches the end of the light ray it continues as a circularly polarized wave. That this is pure rubbish is so apparent that even the most misguided neophyte in radio would be capable of seeing it. What actually happens, and this fact was proven by me beyond all question of a doubt, is that the relatively low frequency radio wave modulates the high frequency light wave and the modulated light wave proceeds as an invisible light ray. This may seem strange but, to anyone who has had the opportunity of seeing it, it will be obvious.

It can also be proven mathematically. Let $W=2\pi f$ where f is the frequency of the light wave (7.7×10^{14}), conveniently termed super-radio frequency, and let $P=2\pi f'$, where f' is the frequency of the modulated radio wave.

Then $i=L_s \text{ sine } wt \text{ sine } pt$ where sine pt is a modulating factor due to the radio frequency supply at any instant.

The above equation, it must be explained to the readers of *QST* is nothing more than a dark light wave. In other words, the light wave does not come to an end, as the eminent Dr. Taurenwerfer assumes, but continues invisibly with the radio wave to its destination.

It must be obvious that my theory is far more plausible than Doc Taurenwerfer's

since it not only explains the disappearance of the light ray, but also shows why the radio wave continues. Taurenwerfer's nonsense about circularly polarized waves is entirely superfluous. As to Dr. Taurenwerfer's circuit, the less said the better. It is a direct steal from the one I published in 1897 in the Journal of the Tibetan Radio Institute (See also Arnold's *Light of Asia* vol 11 p 963). If Dr. Taurenwerfer had referred to a later article of mine in the Radio Ephemeris, he would have discovered that I had developed a far simpler method of shielding the primary inductance from itself. Instead of winding it inside a copper coil (these have far more important uses in this day and time) I merely doubled the wire before winding and then wound it non-inductively. As for designing this inductance to carry the enormous currents, my native originality soon enabled me to solve this problem also. I shunted the coil with a short section of third rail (possibly for 3rd harmonic transmission—Assoc. Ed.) which a conductor on the Third Avenue "L" in New York City kindly furnished me. I had some difficulty in getting this last piece of equipment owing to high tariff on steel rails, in the Island of Yap. It was only with greatest difficulty that I was able to con-

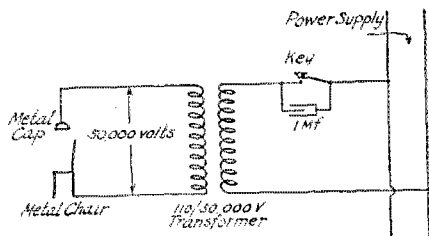

DIAGRAM OF THE IMPROVED TAURENWERFER SUPPRESSOR

vince the custom officers that this section of rail was not intended for the Yap subway.

It would be somewhat unethical in the pages of this journal to refer to Dr. Taurenwerfer's explanation of the Taurenwerfer Suppressor, as I feel inclined to do. It is apparent that he does not understand the first principles of constructing a Taurenwerfer Suppressor. Since reading his article I have constructed a Taurenwerfer Suppressor. I would be only too glad to demonstrate it to him if he will honor me with a visit. It is shown in the illustration. Its operating features are so simple that an explanation is unnecessary. The Taurenwerfer sits on the chair and we press the key. Presto! Taurenwerfer is suppressed.

—A. W. Kramer, 9CPV

The Other Way Around

Wickford,
Essex, England.

Editor, QST:

I see according to a recent issue of QST that there is another DX record of 16,000 miles set up between California and South Africa. You will remember my little DX record when I worked u601 one afternoon last winter. We all thought that was a DX record of some 16,000 miles. As I was in

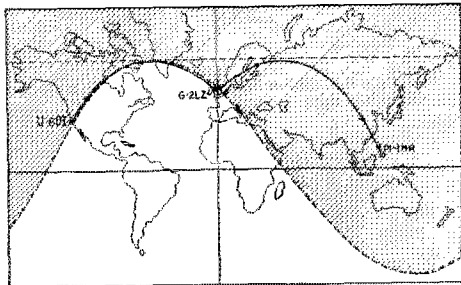

regular daily communication with the Philippines at this time we naturally assumed that my signals carried on, traveling in the same direction until they reached California. At the same time of the day it was quite impossible to work the Eastern side of the States when operating in the 40-meter band.

I am enclosing a theory from a local enthusiast which rather explodes our ideas of the signals travelling the long way around. I think this a very feasible explanation and think it should be published in QST so that other opinions may be had.

—S. A. Mayer, g2LZ

Avonhurst, Rectory Lane,
Chelmsford, England.

Dear Mr. Mayer:

I think the accompanying sketch explains your working with California at 1530 G.M.T. in the winter months here. The distribution of dark and light at this time as you will see makes the signal path along the edge of the dark portion between here and California to the Westward and it seems reasonable to assume that signals would take this path in preference to the 16,000-mile path which you suggest.

I find a piece of tracing paper with the dotted sunset and sunrise lines as drawn above, which can be moved over the map with a time scale, a useful way of finding the conditions at any time. This curve can be re-drawn of course for different seasons and at the equinox will become two straight vertical lines.

—K. W. Tremellen

Watch the Intermediate

Vulcan, Alberta,
Canada.

Editor, *QST*:

I don't know if Headquarters has noticed how careless some of the stations are about the intermediate sign, but I have had considerable rounds of grief in this connection. It seems to me that the Canadian stations would appreciate it if this point were brought to the attention of the operators who read this section.

Why is it that so many operators do not pay any attention to the intermediate sign? A good many of them ramble on all night without the slightest thought of how important it is and how much loss of time it can cause another station through this neglect. On a good many occasions I have spent over half an hour before I could give "GN SK" and explain that I was not in North Carolina or Florida and that I could not QRS as I was a c4 and not a u4. With some stations I have tried to break-in to QSK the long messages already started, but ND, so they ramble all through the stuff while I sit back and feel most unnecessary. By the time a very heavy intermediate has been soaked at these fellows and you give him your QRA a few times you have lost the best part of a half an hour, just because the other fellow paid no attention to the intermediate when you first called him.

To be taken for a New Zealander, after leaning heavy on the intermediate, and told how "glad to QSO es first nz. station wkcd hr", you feel quite embarrassed to say the least. You wonder how he will like the disappointment that is in store for him when you tell him Canada and not New Zealand, and you come back and comfort him with plenty of "OM's". Then the QSO is ended abruptly by "sorri OM gess nil hr caugn 73". No pleasure or information is gained from this kind of contact and in most cases we don't even get a QSL card. If the fellows would watch the intermediate signs a lot of trouble would be saved.

—A. J. Ober, c4DQ

QSL, QSL

U. S. Naval Radio Station,
San Juan, Porto Rico.

Editor, *QST*:

As my interest in radio is primarily one of study of various phenomena, it is oftentimes very helpful if the particulars of the transmitter whose signal has been logged, are known. With this in view I have during the past two months mailed cards to fifty stations, with the result that eighteen of them brought a return card for which I desire to express my sincere appreciation. To those who did not QSL, however, I can only say that QRW is sometimes an excuse for fail-

ure to QSL but we all know that none of us are busy *all* of the time. Perhaps some of the amateurs do not think it is worth a two-cent stamp and a two-cent card to QSL to a fellow amateur who has nothing more in the way of a transmitter than a low power 201-A tube. Porto Rico is no mean DX for some of those to whom I have sent QSL cards, but perhaps nothing under a million miles is DX for those few.—E. R. Mayer, Pr4KD.

Slow 'Em Down!

1508 Harbert Avenue,
Memphis, Tenn.

Editor, *QST*:

I have had twelve years experience, both in Morse and wireless, with a bug and have been a student of that machine. In referring to the use of a vibrating machine, stress the fact that to gain speed is *not* their prime purpose. Their chief use is to enable the sender to make perfect characters. Making perfect characters is the *only way speed can be had*. The operator who uses an open, slow, heavy enough bug will in an hour, a day, a week, a month or a year move more business with a minimum number of "bulls" than any other man can move with a fast bug. By timing the dots and dashes of the hand and the bug, I find that the difference is not great enough to cause an increase in speed, but the ease of sending, the perfection of characters and judgment in their use will bring surprising speed, whereas a faster vibrating bug has only the effect of making its user believe that the noise he is making is speed.

By carefully forming each character and exerting an effort to make it so that the receiver can get it "falling down" will be eliminated, and although it may sound slow a check up after sending some time reveals the fact that the secret of speed is no longer a secret. Although it is an impossibility to make some operators realize it, there is no profit to show how fast one can send. It takes only a short time at this careful sending until it becomes habitual, and another good sender is born. Incidentally all commercial Morse men have a habit of being "broke." If one wishes to begin using a semi-automatic sending machine they usually can be obtained from some Western Union relay operator for five to ten dollars!

—C. W. Pate

Your QSL Cards Free

Calgary,
Alberta, Canada.

Editor, *QST*:

This is a sample of a large number of QSL cards that were supplied to us free by "The Calgary Exhibition Co., Ltd.". Credit is

due c4AX and c4IO for the design. It will be seen that in the lower right hand corner there is a space for your own call, but a rubber stamp can be used in the lower left instead. This card is attractive and novel



"THE BRONCHO (ETHER) BUSTERS"
ALBERTA RADIO EXPERIMENTERS ASSOCIATION
(Affiliated ARRL)

Dear OM: (If sigs _____ Alberta, Canada
MST. _____ 1926. And: R _____
QRM. _____ QRP _____ QSB _____ QSS _____
Junk fr: _____ tubes
In _____ Pkt. Input _____
Volts _____ Ant: Curr: _____
The QSL card _____
73 fm. _____ On: Cdn: 4. _____

and we feel sure that it will be appreciated by the hams who are lucky to get one.

I would suggest that ham organizations approach their local Board of Trade for a supply of QSL cards. Explain the world-wide use of the QSL card let them advertise your city and at the same time help your organization. Of course there are many other sources of supply other than the Board of Trades. For heaven's sake break away from the sameness in cards. Get something that is original and therefore attractive in more ways than one.

—F. E. Macdonald, c4AG

CROSLEY

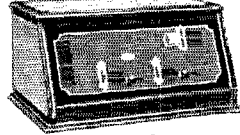

**5-Tube 5-50
Single Dial
Control \$50.
with Drum
Station Selector**

6 Amazing Features

1. All-metal Shielded Chassis
2. Power Tube Adaptability
3. Crescendion Control
4. Accuminators
5. Graphic Station Selector
6. Solid Mahogany Cabinet

See it at your dealers

Six other models from 1-tube at \$9.75 to 5-tube RFL Console Model with built-in Musicone at \$90.

Write Dept. 18 for Booklet

THE CROSLEY RADIO CORP.
Cincinnati, Ohio

Prices slightly higher west of the Rockies.

YAXLEY

APPROVED RADIO PRODUCTS

MIDGET BATTERY SWITCH

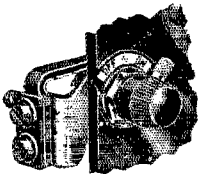

YAXLEY No.10

The most efficient filament control switch made. Never gets out of order. One nut mounting in 7/16" panel hole. Hard rolled phosphor bronze springs, pure silver contacts. Terminals tinned for soldering. Insulated

from brass frame. Quick make and break. Furnished complete with "Off" and "On" plate, as illustrated.

No. 10—Midget Battery Switch.
Each 50c. At all Good Radio Dealers.

YAXLEY MFG. CO., Dept. Q
9 So. Clinton St., Chicago, Ill

Laboratory Product



CRESCENT LAVITE RESISTANCES

for Distortionless Amplification

Dual resistance for DeForest "H" tube \$3.50. Consists of two units mounted on bakelite and connected in parallel.

Please specify if your "H" tube requires 60,000 ohms or 20,000 ohms

All amateur apparatus in stock. Let us drill and engrave your panels

CRESCENT RADIO SUPPLY CO. 1 Liberty St., Jamaica, N. Y.



NOW--

EFFICIENT RECEPTION

AT MINIMUM COST

The New TECO Receiver tunes 10 to 200 meters

(1500-30,000 K. C.)

Parts used in the construction of this receiver include Cardwell condensers, General Electric UV 712 audio transformer (ratio 9 to 1, 1000 cycle), the new TECO plug-in coils (five in number, wound on protectoid) vernier dials and a bakelite panel ENGRAVED WITH YOUR CALL LETTERS

\$27.50

The TECO line of radio apparatus includes 3000 volt transmitting filter condensers, mica blocking condensers, and other items of interest to the amateur. We are also agents for DeForest transmitting tubes. Write for literature.

Transmitting Equipment Co.
19 Stuart St. Boston, Mass'

Q - R - H ?

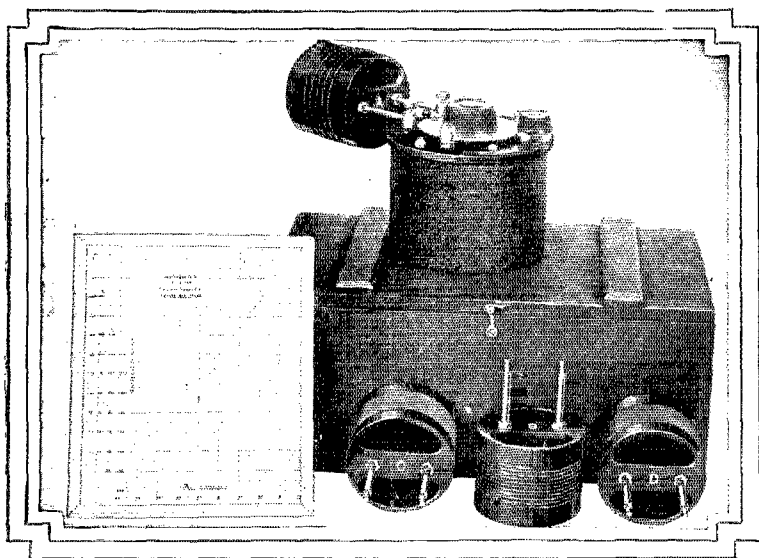

The General Radio Type 358 Wavemeter

The type 358 wavemeter is designed particularly for experimental use. As it covers a wavelength range of 15 to 225 meters, it covers all the amateur bands in common use. The wavemeter consists of a set of four mechanically rugged coils of low loss construction mounting interchangeably on the binding posts of a shielded condenser of 125 MMF capacity. A resonance indicator lamp is connected in series with the condenser and coil. When the lamp is removed the socket in which the lamp is mounted becomes short circuited.

The wavemeter is equipped with the following coils calibrated with an accuracy of within 1%:

Coil A	15 to 30 meters
Coil B	25 to 60 meters
Coil C	50 to 115 meters
Coil D	100 to 225 meters

Coils A, B and C are space wound on threaded bakelite form to maintain accurate calibration.

Ask your dealer or write for our descriptive folder 358—Q.

Price of wavemeter complete in wooden carrying case \$22.00.

GENERAL RADIO CO.,

Cambridge, Mass.

GENERAL RADIO

INSTRUMENTS

"Behind the Panels of Better Built Sets"

THESE EDGES



won't admit moisture

THE leaky spot in ordinary mica condensers is the exposed edge. That is where moisture slyly creeps in—atmospheric moisture, salt air, steam from radiators, and acid fumes that corrode, create resistance and cause a condenser to change its capacity.

SANGAMO

Mica Condensers

have no exposed edges. The delicate parts inside are protected by an armor as hard and impermeable as marble.

Use them anywhere—and anyhow—expose them to acid fumes, boil them, freeze them, drop them on the floor, solder wires to the terminals—and you will still have accurate condensers.

They cost little—and make a world of difference in tone, accuracy and range. Recommended by every nationally known radio laboratory and by professional set builders.

Try
SANGAMO BY-PASS
CONDENSERS
they won't break down



Sangamo Electric Company
6332-4 Springfield, Illinois

RADIO DIVISION, 50 Church Street, New York

SALES OFFICES—PRINCIPAL CITIES

For Canada
Sangamo Electric Co. of Canada, Ltd., Toronto
For Europe
British Sangamo Co., Ponders End, Middlesex, Eng.
For Far East
Ashida Engineering Co., Osaka, Japan

ACME ENAMELED ANTENNA



Best outdoor antenna you can buy. 7 strands of enameled copper wire; maximum surface for reception. Prevents corrosion and consequent weak signals.

The Original Celatsite

—a tinned, copper bus bar wire with non-inflammable "spaghetti" covering, for hook-ups. 5 colors; 30 inch lengths.

We also offer the highest grade of "spaghetti" tubing for Nos. 10 to 18 wires. 5 colors; 30-inch lengths.

Send for Complete Folder
of Acme Wire Products

ACME WIRE CO., DEPT. S, NEW HAVEN, CONN.



ACME WIRE

MAKES BETTER RADIO

TRANSMITTING KITS RECEIVING

Extraordinary Values!

\$24⁷⁵ each

TRANSMITTING KIT

Complete parts for 7½ Watt
40-80 meter Transmitter
RCA UX 210 7½ Watt Tube. ARSCO NO LOSS Inductance, Roller Smith antenna meter, Cardwell antenna series condenser, Cardwell primary condenser, Clips, grid and baseboard furnished; Sangamo Grid and Plate condensers, General Electric grid load RCA power rheostat, Radio frequency choke, Standard socket, complete instructions.

RECEIVING KIT Complete parts for NO LOSS Short Wave Receiver
7 inch by 18 inch Bakelite panel, Radion Sub panel, Benjamin choke absorbing sockets, (sockets attached to sub panel), Marco Vernier dials, Hammerlund .00014 S. L. F. condenser, Hammarlund .00025 S. L. F. condenser, Set of R. E. L. coils, R. F. choke, High ratio audio transformer, Jack-Switch-rheostat, Binding posts Radio panel, brackets, etc.

Send for our FREE catalog!

AMATEUR RADIO SPECIALTY COMPANY

77 CORILANDT ST. NEW YORK CITY

CONDENSERS

800 Volt Eliminator, .1, .25, and .5	50c
1, 2, 3 and 4 Mfd, per Mfd.....	60
1500 Volt Transmitter, .1, .25, and .5.....	65
1, 2, 3 and 4 Mfd, per Mfd.....	75
2Mfd Salvaged for eliminators.....	75
Acme Transformers and Chokes.....	

The Radio Club Inc., LaPorte, Ind.

SAY YOU SAW IT IN Q S T—IT IDENTIFIES YOU AND HELPS Q S T

Even In "Greenland's Icy Mountains" This Set *Must Not Fail*

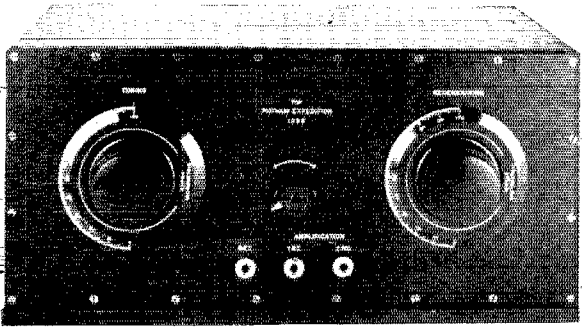
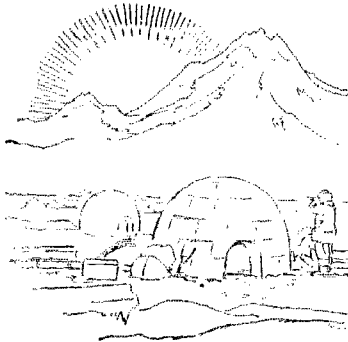

—And Karas Apparatus Was Chosen

To insure communication at all times, a short wave receiver was *built to order* for the American Museum Greenland Expedition. To withstand the extremes of cold and dampness to which such a set would be subjected, only the finest parts could be used. Karas Orthometric Condensers and Karas Micrometric Vernier Dials were the choice of the expert who guaranteed that set's performance.

Karas Micrometric Vernier Dial is a recent achievement of Karas engineers which tunes to 1/1000th of an inch with a ratio of 63 to 1. It turns easily with a liquid-like smoothness and there is no possibility of back-lash. Rough tuning may be done with the larger knob but the vernier is continuous from end to end of the scale. Dial markings in gold inlay—200 divisions instead of the usual 100—available clockwise or counter-clockwise—either 180 or 360 degree rotation. Diameter 4 1/2". Price \$3.50 each.

The Karas Orthometric Condenser, with its straight frequency line tuning characteristics and brass plates, is preferred by leaders in short wave work. 5 plate .0001, \$6.50; 7 plate .00014, \$6.50; 11 plate .00025, \$6.50; 17 plate .00037, \$6.75; 23 plate .0005, \$7.00; special 17 plate with extended shaft for Equamatic System, \$7.00.

Karas Harmonik audio transformers, placed in either a short wave CW outfit or a broadcast receiver, give the highest voltage amplification known—without distortion. Price \$7.00 each.

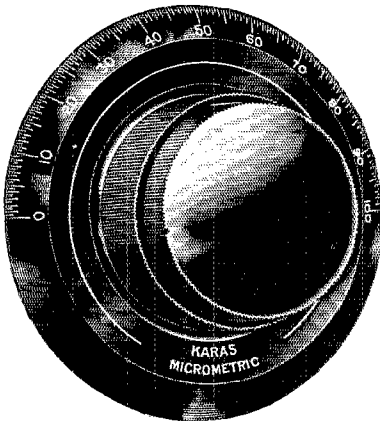

New Karas Micrometric Vernier Dial in which there can be no backlash.

Inside view of special made-to-order receiver.

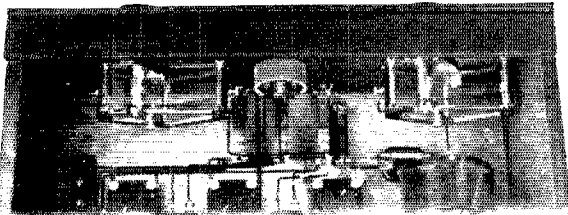

KARAS ELECTRIC CO.

Factory: N. Rockwell St. :: Offices: 1060 Association Bldg., Chicago

Karas Electric Co., 1070 Association Bldg., Chicago

Please send meKaras Harmonik Transformers,
.....Karas Orthometric Condensers,
.....Karas Micrometric Dials,

sizes as checked below. I will pay the postman the price plus postage upon delivery. It is understood that I have the privilege of returning these condensers, dials and transformers for full refund any time within 30 days if they do not prove entirely satisfactory.

...5 plate; ...7 plate; ...11 plate; ...17 plate; ...23 plate
Dials, ...O-Right, ...O-Left, ...180°, ...360°

Name

Address

If you send cash with order, we'll ship condensers, dials and transformers postpaid.

GROSS SHORT-WAVE APPARATUS PLUG-IN COILS

General Radio Jacks and Plugs used. Most efficient plug-in arrangement on the market.

Can be handled freely without fear of injuring coils, also making possible permanent calibration of set.

Minimum amount of dielectric insures lower losses resulting in stronger signals and sharper tuning.

Without question the most rugged receiving coil on the market.

Spaced winding insuring minimum distributed capacity.

Price for 80 Meter Band complete with Base (58 to 115 meters) \$5.50.

Price for 40 Meter Band (30 to 60 meters) \$5.50. Complete with Base. Separate coils for 20, 40 or 80 meters \$3.00.

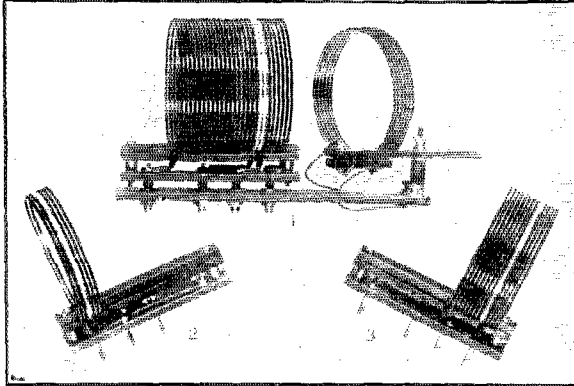

The Original Pancake Inductances for 20, 40, or 80 meters, \$5.00. Quartz Crystals, \$6.75. Transmitters of any power or band. Send stamp for circulars describing full line of transmitting and receiving parts.

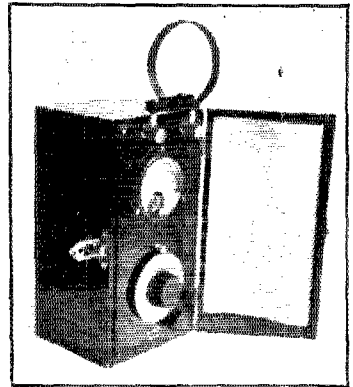

GROSS WAVEMETER

Built into rugged and handsome cabinet, handy size, removable cover. Low-loss inductances and condenser insure a low resistance wavemeter. Separate curve for each coil checked against oscillating crystal. Accuracy better than 1% guaranteed.

Type I—with flashlamp indicator—for 20, 40, 80, meter bands, \$15.00; for 20, 40, 80, 200, meter bands, \$18.75.

Type G—with galvanometer—20, 40, 80, meter bands, \$30.00; for 20, 40, 80, 200, meter bands, \$33.75.

J. GROSS & CO.,

30 PARK PLACE, NEW YORK CITY

PIEZO ELECTRICAL CO.

INCORPORATED

PIEZO-ELECTRIC PRODUCTS

LYNN, MASSACHUSETTS, U. S. A.

GUARANTEED ACTIVE QUARTZ CRYSTAL

PRICE \$5.00

A NEW WAY TO SELL RADIO CABINETS WHO EVER HEARD OF SUCH A THING BEFORE?

We have placed on the market two NEW STYLES on which we give you choice of stock sizes at the same price. Our "Piedmont" is made of hardwood, fancy nicked hinges, three coats of the new lacquer varnish rubbed to a hard smooth glossy finish, mahogany finish only.

Sizes 7" x 18" x 10", 7" x 21" x 10", 7" x 24" x 10", 7" x 26" x 10"—YOUR CHOICE AT ONLY \$2.65 EACH. Cash with order, no C.O.D., f.o.b. Hickory.

We challenge anyone to show us a cabinet of this fine quality selling at such a low price. We have been making cabinets for four years—a few cents profit on each one but a big production.

SEND FOR CATALOGUE—ITS FREE

THE SOUTHERN TOY COMPANY, INC.

HICKORY, NORTH CAROLINA.

DEPT. Q

A combination of advantages
available to set owners for the
first time in the History of Radio

ELKON TRICKLE CHARGER

Keeps "A" Batteries automatic-
ally at highest efficiency, without
any attention or trouble.

No acid or alkali
to spill and fume

No water
to be replenished

No tubes
to break out or burn

No moving parts
to get out of order

No noise or interference

Cannot overcharge
Tapers and increases
automatically

Short circuiting
cannot harm in *any way*

Needs no adjustments

Jolts or jars do not affect

Can be operated upside down
or in any other position

Does not heat

Full Wave

For sale at all radio dealers, or write

ELKON WORKS
Subsidiary of P. R. Mallory & Co. Inc.
Weehawken, N. J. Inc.

Sole licensees under patents pending to Samuel Ruben

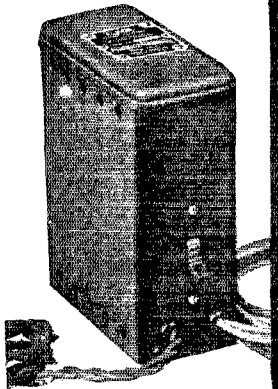

Operates from
105-125 volts,
25-60 cycles,
direct from A.C.

\$15 00
Complete
With Switch

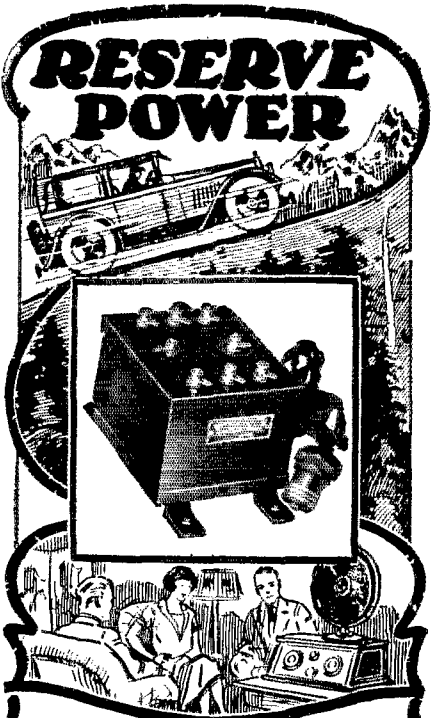

RESERVE POWER

THORDARSON

POWER AMPLIFICATION AND B-SUPPLY FROM THE A. C. LINE

Force a car up a steep hill and the engine knocks. Force a radio set and the quality becomes ragged and the reproduction distorted. Faithful reproduction of the deeper bass tones requires a considerable expenditure of electrical energy,—more, in fact, than the vacuum tube of the average receiver can handle.

A power amplifier built with Thordarson transformers and chokes uses larger capacity tubes and reproduces the heavier, more vibrant tones with undistorted quality and volume.

TRANSFORMER R-198 supplies 500 V. plate and 7½ V. filament for UX 210 tube. Price \$12.00
 30 Henry Choke R-196, 70 M.A. capacity for filter circuits. Price \$5.00

THORDARSON ELECTRIC MFG. CO.

500 W. Huron St., Chicago, Ill.

Transformer Specialists Since 1895
WORLD'S OLDEST AND LARGEST EXCLUSIVE TRANSFORMER MAKERS

SM

635 Short Wave Kit

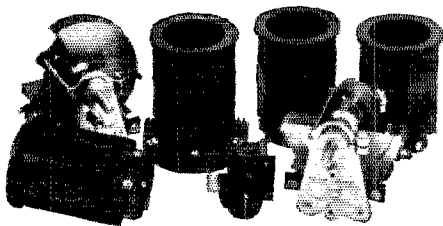

The type 635 Short Wave Receiver Kit contains the carefully designed and matched essentials for constructing a receiver with a wavelength range of 18 to 150 meters, and a practically unlimited distance range.

In addition to a set of Type 117 plug-in coils, the kit includes a 515 coil socket, 340 antenna coupling condensers and a pair of 317 tuning condensers. These parts are all carefully designed for operation together, and using them a most excellent short wave receiver may be built.

With the four coils supplied, the various amateur transmitting bands fall well to the center of the tuning condenser scale, and may be shifted as desired irrespective of normal antenna lengths. Due to the design, "dead spots" at which the receiver will not oscillate are totally eliminated. The antenna condenser allows of easily adjusted variations of antenna coupling to suit individual conditions of location and antenna. Price \$23.00.

At your dealer's.

Silver-Marshall, Inc.

858 West Jackson Blvd., Chicago, Ill., U. S. A.

THE TUBE WITH THE SENSIBLE GUARANTEE

Definite Quality!

WHEN YOU BUY ORDINARY TUBES YOU ARE BUYING DOUBTFUL QUALITY

Tubes may leave a factory in good condition but whether they reach you that way is "Doubtful." Because it is commonly known that ordinary constructed tubes may be disqualified in handling—Therefore if they are good after you receive them, it's just "luck," and even luck is doubtful.

WHEN YOU BUY NEW SUPERTRONS YOU ARE BUYING DEFINITE QUALITY

Supertrons are internally reinforced—so that the three elements are tied into one unit. They are vibrationless—Uniform and Oh Boy! what quality—DEFINITE QUALITY!

Guaranteed by a serial number—to assure a refund if they are not better.

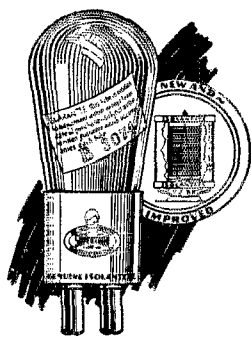

VIBRATIONLESS, UNIFORM and GOOD

Supertron Mfg. Co. Inc., Hoboken N. J.

Chicago Office 30 North Dearborn St.
 Export Dept. 380 Broadway N. Y. C.



SUPERTRON

A SERIAL NUMBER GUARANTEE
 The Foremost Independent Tube Mfg. in America

Cardwell

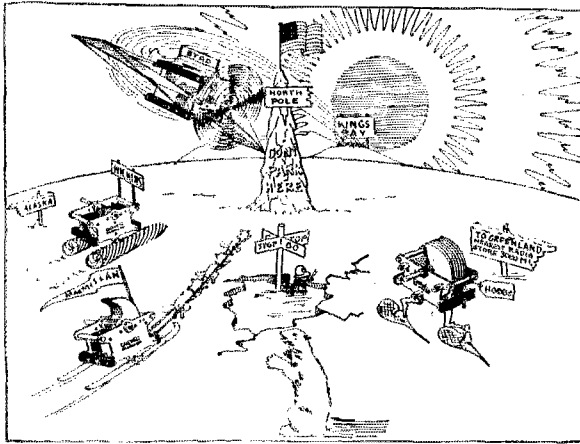

FIRST TO THE POLE!

Months Ago We Knew!

Cardwell Condensers must be first at the pole, for every polar expedition used them!

Where success, and often life, depend on the reliability of the equipment, you are sure to find Cardwells.

TRANSMITTING VARIABLE

Capacity Mmfd.	Type No.	Breakdown Voltage	Price
250	164-B	3000	\$ 7.00
440	147-B	3000	10.00
80*	197-B	3000	8.50
217*	157-B	3000	12.00
156	183-B	5250	15.00
297	166-B	7600	70.00
480	123-B	1400	5.00
480*	156-B	1400	7.00
980	137-B	1400	7.00

FIXED

Capacity Mmfd.	Type No.	Breakdown Voltage	Price
250	501	3000	\$ 4.50
440	502	3000	7.00
966	503	3000	10.00
250	504	5250	15.00

* Has two insulated stators - capacity of each.

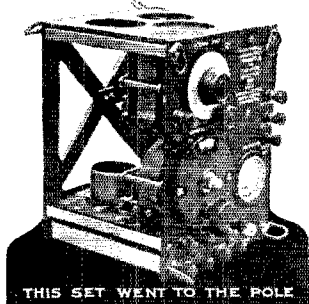

THIS SET WENT TO THE POLE

WIDE WORLD PHOTOS

Nearly every amateur heard KEGK nightly during the progress of the Byrd expedition, and they were QSA during the whole time.

The plate tuning condenser was a Cardwell — through necessity. Other condensers originally used broke down before they left New York harbor.

The compact 50-watt set on the left was carried on the airplane "Josephine Ford" and first flashed back the news of success!

The Allen D. Cardwell
Manufacturing Corp.
81 PROSPECT STREET
BROOKLYN, N. Y.

2QA gld QSO anytime 11.30 to 12 a. m.
es 4.30 to 5 p. m. E. S. T. QRK?

Send for 36-page handbook and catalogue

RECEIVING

The Type E is near straight frequency.

The Type C gives a modified straight wavelength.

Type "E"	Type "C"	Capacity Mmfd.	Price
191-E	167-C	75	\$3.75
167-E	168-C	150	4.00
168-E	170-C	250	4.25
169-E	171-C	350	4.75
192-E	172-C	500	5.00

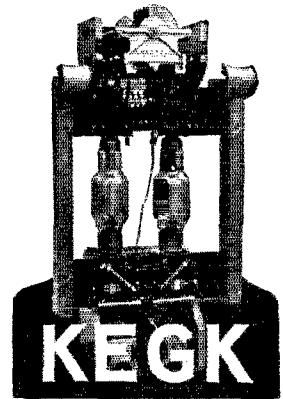

KEGK

WIDE WORLD PHOTOS

Condensers

THE STANDARD OF COMPARISON
SAY YOU SAW IT IN Q S T—IT IDENTIFIES YOU AND HELPS Q S T

YOU NEED THESE PLUG-IN COILS

Note the many advantages of these better and different coils listed below and try to do without them.

1. Positive contact is secured through General Radio plugs and jacks.

2. With 3 Coils, continuous, gapless range is secured from 140 to 16 meters. One of the 20-40-80 meters

amateur bands is located in the middle of the tuning range of each of the 3 coils. (For this a SFL Condenser, 140 mmfd. max. cap. is essential.)

3. Operation of regeneration condenser has no effect on the tuning; the 2 controls are completely independent.

4. Antenna coupling is adjustable; by a primary coil

and not through a condenser. Secondary coils are specially constructed so that setting of primary coil does not need to be changed when secondaries are exchanged.

5. Coils are space-wound solenoids on skeleton frames.

6. Both tickler and antenna coil are at filament end of the secondary.

7. These coils cover the 3 U. S. Amateur Bands, all European Amateur Bands, Short-Wave Broadcast, U. S. Naval and Commercial Short-Wave Stations, etc.

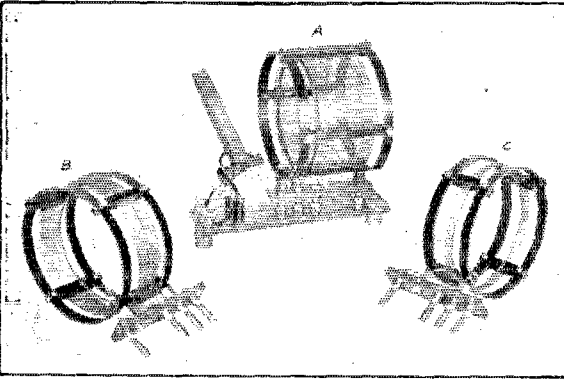

The Kit Illustrated Covering 15 to 133 Meters Complete **\$12.50**
 Coil No. 4, 125-250 M Price \$4.00 Coil No. 5, 235-550 M Price \$4.00

These coils are essential to the most efficient operation of your station. Order your TODAY.

AERO PRODUCTS INCORPORATED, Dept. 16, 1768-1772 Wilson Ave., Chicago, Ill.

Radiohms and Potentiometers

Centralab non-inductive, variable resistances are controls of graphite type that insure smooth, noiseless tuning and permanent service. A single turn of the knob gives stepless variation of resistance from zero to maximum. Centralab Radiohms have two terminals, and can be furnished with maximum resistances of 2,000, 25,000, 50,000, 100,000 or 200,000 ohms. Centralab Potentiometers have three terminals, and are furnished in resistances of 400, 2,000 and 500,000 ohms. There is a type adapted to every radio circuit for control of oscillation or volume.

Write for literature describing these and other Centralab super-quality controls.

Central Radio Laboratories
 20 Keefe Ave., Milwaukee, Wis.

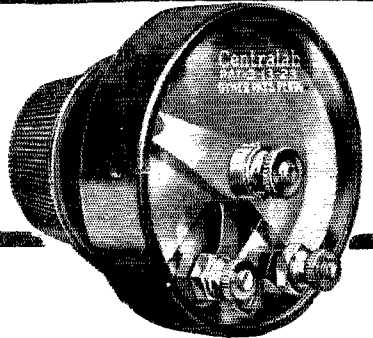

Centralab

THE CRICKET KEYS

The latest thing in radio. Absolutely new principle. So simple they look foolish.

On the air successfully for six months.

The only key for beginners. The best key for old Hams.

NO BUM FISTS. NO GLASS ARMS. ONE PORTABLE. ONLY PORTABLE MADE.

We recommend desk CRICKET for beginners.

Automatic. Easy learned. Easy operated. Easy read through QRN. Fast. No mental strain. Beginners teach themselves.

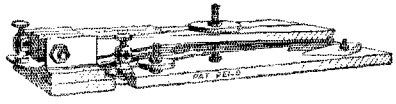

Prices Moderate

Listen to 5EH

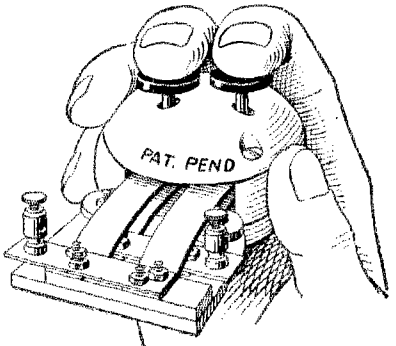

Write **F. F. Mace & Son, 132 Sunset Ave., Dallas, Texas**

A Master Product!

Designed for Reliable
Long Distance Communication
on
1 Meter to 200 Meters

INPUT RATING 150 WATTS

Plate Voltages 500-3000

Plate Currents 40-50 MA.

Fil. Voltage 10

Fil. Current 2.35A

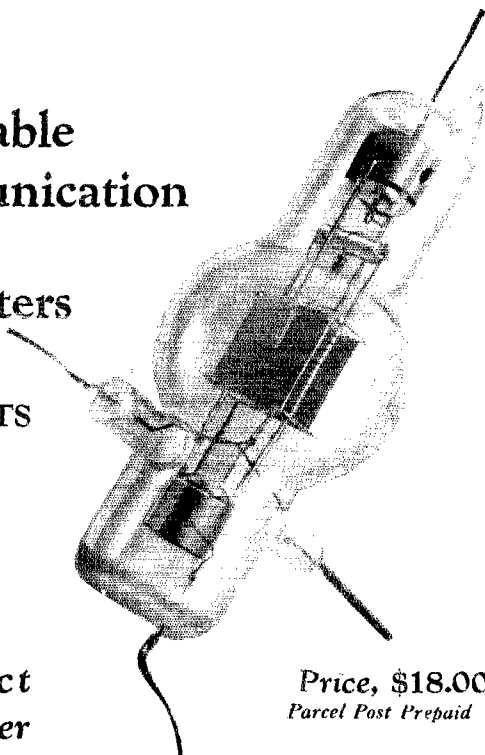

Sold and Shipped Direct
Upon Receipt of Money Order

Price, \$18.00
Parcel Post Prepaid

DE FOREST

TYPE-H

TRANSMITTING TUBE

139 Franklin St., DE FOREST RADIO CO., Jersey City, N.J.

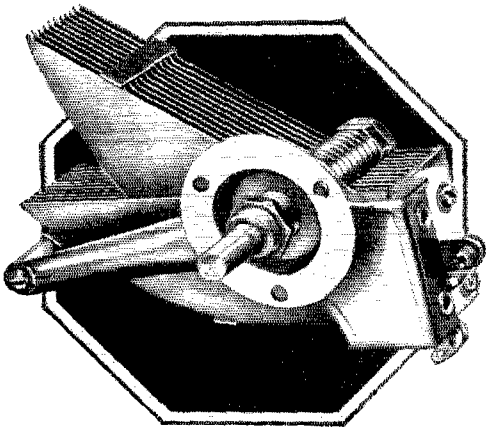

For short wave work

*The Pacent True Straight Line
Frequency Condensers
Have No Equal*

THE complete line of Pacent True Straight Line Frequency Condensers ranges from 3 plates to 23 plates. This permits you to select a condenser for your exact requirements whether it be short wave work or broadcast reception.

These are priced from \$2.75 for the No. 251-S with 3 plates to \$4.50 for No. 251-C with 23 plates.

You can be absolutely sure of perfect straight line frequency operation with wide accurate spacing of stations when a Pacent Condenser is installed in your set.

*Ask your dealer or write us direct
about these and other Pacent
Radio essentials*

PACENT ELECTRIC CO., INC.
91 SEVENTH AVENUE NEW YORK CITY

Canadian Licensed Manufacturer :
White Radio Limited, Hamilton, Ont.

Manufacturing Licensees for Great Britain and Ireland:
Igranic Electric Co., Ltd., London
and Bedford, England

Pacent

RADIO ESSENTIALS

EAGLE



All That's Best in Radio

Eagle Owners have the satisfaction of knowing they have the best Radio Receiver made, regardless of cost.

Ask Your Dealer



EAGLE RADIO COMPANY
16 Boyden Place Newark, N. J.

*Announcing slogan
contest winner*

**"For
sound
reasons"**

The
Magnavox Tube



A \$25 *Magnavox* Loud Speaker is awarded as first prize to W. W. Brackenridge, Harrison, Ohio, for his slogan, "For Sound Reasons." Second prize of 5 *Magnavox* tubes to Arthur Kemp, Hollywood, Cal., for his slogan, "Non-microphonic, long-life." This contest, announced in May and June Q.S.T. created marked interest. We received many entries and sincerely thank each contestant for his effort. We found that a majority of entrants use the *Magnavox* Tube. Its non-microphonic quality coupled with its suitability for short wave work make it ideal for amateurs.

The Magnavox Company, Oakland, California

The Coil's the thing!

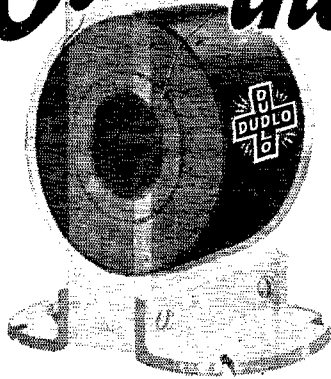

No Radio Unit
Is Any Better
Than Its Coil

that
makes
Radio

EVERY Electrical or Radio Engineer knows that *it's the coil that does the work* in electrical apparatus.

The audio transformer is a good example of this important truth. Unless the coil is just right—to the minutest detail—improper amplification distorts the true tone values of an otherwise fine set.

The most successful manufacturers of Radio and other electrical apparatus now realize that *coil winding is so highly a specialized field* of Electrical Engineering that it pays from every standpoint—quality as well as economy—to use Dudlo Coils.

This is manufacturing wisdom that shows up in the profit column.

If you are an electrical manufacturer, you are probably using Dudlo Coils now. If not, you are cordially invited to make our experimental laboratories a department of your own organization. We will either assist you in the design and development of your coils or quote on coils built to your specifications. Correspondence invited.

DUDLO

MAGNET WIRE AND WINDINGS

DUDLO MANUFACTURING CORPORATION

Eastern Office
Office and Warehouse
NEWARK, N. J.

MAIN WORKS AND GENERAL OFFICES
FT. WAYNE, INDIANA

Chicago Office
160 N. La Salle St.
CHICAGO, ILL.

412 Chamber of
Commerce Bldg.

Western Office:
274 Brannon St.

SAY YOU SAW IT IN Q S T—IT IDENTIFIES YOU AND HELPS Q S T

American Transformer Company

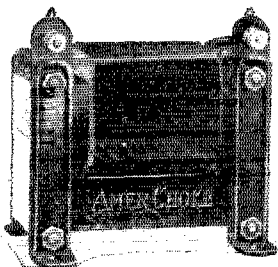

The AmerChoke

Most satisfactory in the long run is the set of dependable parts throughout. One of the most reliable and useful of AmerTran products is the AmerChoke Type 354—a choke coil or impedance designed primarily for use in filter circuits. As an output impedance with a fixed condenser it forms an ideal filter for the loudspeaker, insuring tone quality equal to and more economical than the average output transformer. For filter circuits in B eliminators, the AmerChoke will give excellent results due to its scientific design and generous proportions.

AmerTran Power Transformers are also of high efficiency—and are especially adapted to the use of the 7½ volt power tubes in the last audio stage. After rectification, they supply sufficient plate current for the operation of the set.

In two stages, AmerTran De Luxe Audio Transformers are famous for the natural tones developed over the entire audible range. Whatever else a set may have—if it is good, the use of these transformers will make it better. You may pay a little more but you will get a great deal more.

Write today for interesting free booklet—"Improving the Audio Amplifier"—and price list.

AmerTran Products Are Sold Only at Authorized AmerTran Dealers

AMERICAN TRANSFORMER CO.
178 Emmet Street Newark, N. J.

**Transformer Builders for
Over Twenty-Five Years**

A NEW TOBE PRODUCT



The TOBE Veritas Hi-Current Resistor is made to carry from 4 to 5 watts continuously without change. It is no longer than an ordinary grid leak, although the diameter is large to increase its radiation. It can be soldered directly into circuits without danger of end caps coming off and is recommended for transmitting grid leaks and for other purposes where high-current carrying capacity is required. Particularly suitable for use with DeForest H Tubes.

PRICE LIST

10,000 ohms and under	\$1.10 each
50,000 ohms90 each
100,000 ohms80 each
1/4 to 1 megohm75 each

Tobe Deutschmann Co.

Engineers and Manufacturers
Cambridge, Mass.

"FOR SALE" AT ATTRACTIVE PRICES

Portable Coil Spark Sets, Type No. SCR-74, made by American Radio & Research Corp., Medford, Mass. Service Buzzers, Signal Corps Model 1914. Condensers, 1, 2, 4 M. F., Stromberg-Carlson & Western Electric Make. 75 Mil Henry Inductances Motor Generators, Instruments, Field Acetylene Signal Lanterns.

Storage Batteries, Navy Radio 210, Ampere Hr. Exide & Gould Make. Also large assortment of minor radio parts too numerous to list.

All this material originates from the U. S. Signal Corps and is for sale at our loft.

SUPREME SUPPLIES COMPANY, Inc.
38 Murray Street New York City
Barclay 6806-07

LEARN THE CODE

with SIGNAL

High Pitch Buzzer and Key Set



Built complete with key, true tone adjustable high pitch buzzer and code plate. Write us today.
Signal Electric Mfg. Co., Menominee, Mich

Rel Radio Frequency Choke Coil

For use in either your Receiver or Transmitter
4" Long. 1" Diam. -- \$1.10

—WOUND ON A BAKELITE FORM—

Send check or money order to
M. B. S. SALES CO., Dept. C.
27 School Street Boston, Mass.

Constant-B

ALL-AMERICAN
TRADE MARK

PERMANENT PLATE POWER

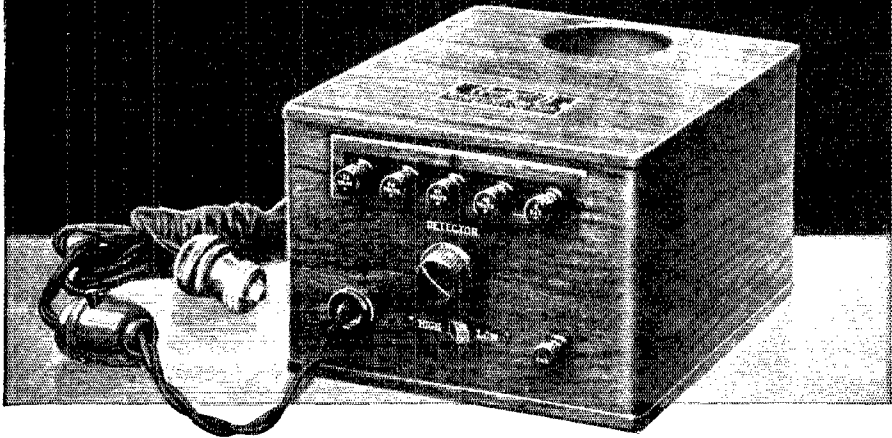

Steady "B" power without batteries

Pure full tone is possible only with "B" voltage kept constantly up to standard; All-American "Constant-B" gives it to you

YOU'VE had your "B" battery troubles; everybody has. Here's a permanent end to them—install an All-American "Constant-B," attach it to a light socket, and turn on the switch. You get a dependable, permanent supply of uniform, constant plate current; insuring full, pure tone.

There's no acid to ruin things; no annoying hum. And all inside units are permanently sealed against atmospheric conditions.

"Constant-B" has taps for 135, 90 and 67½ volts; and a 22½to45 volt tap varied in output by a "Detector" control.

The "High-low" switch insures uniform voltage, regardless of the number of tubes used; "Low" for 2 to 4 tube sets, "High" for sets with 5 tubes or more.

"Constant-B," after passing the highest laboratory tests, carries the seal of approval of the Popular Science Institute of Standards and other testing laboratories. It measures up in every way to All-American's high standards of painstaking workmanship and satisfying performance.

PRICE

\$37.50

Complete with
Raytheon Tube

Descriptive folder and interesting booklet showing how to build a "B" Power Supply similar to "Constant-B" sent free on request. Specify bulletin B-82.

ALL-AMERICAN RADIO CORPORATION

4217 BELMONT AVE., CHICAGO, U. S. A.

Station WENR—266 Meters—is owned and operated by the All-American Radio Corporation

Tune them out and KEEP them out
with *Filtrola* STATION
ELIMINATOR

This attractive compact unit, complete in itself, makes it a simple matter to tune out interfering stations you don't want—even the most powerful. No tubes, batteries or other units to install. A typical All-American product in its precision and quality of workmanship.

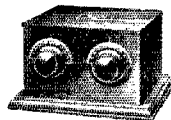

Price \$15

UNSCRAMBLE! THOSE STATIONS!

How often have you wished you could unscramble that station mixup when you wanted to get a particular program? There is only one way to do it. For the old condensers in your set substitute

METRALIGN SLT STRAIGHT LINE TUNING

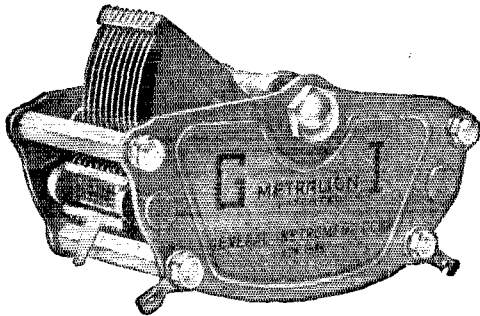

METRALIGN SLT is the only condenser that eliminates the tuning faults of old type condensers by evenly distributing and spreading out all stations, no matter on what wave length—low, intermediate or high over the entire dial, so that the stations you want can be easily and quickly tuned in without jamming or interference.

Free We have prepared a very useful booklet, written in everyday language, covering everything you want to know about condensers. It's FREE—Write for it.

GENERAL INSTRUMENT CORP.

Manufacturers of "Bureau of Standards" Variable Primary Condensers

477 Broadway, New York City

Makes any set a new set-in 15 minutes



B-Power Unit

Specifications No. 1582
For Standard
Raytheon Tubes
\$11.00 List

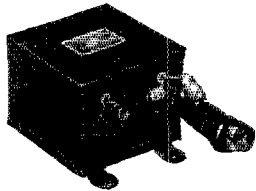

Undoubtedly this new Dongan B-Power Unit (1 transformer and 2 chokes) represents the highest point yet reached in the successful elimination of B Batteries. Built in strict accordance with Dongan's exacting specifications, this compact, smooth-operating B-Power Unit assures efficient B-Power when built according to instructions. In addition to this model Dongan builds various designs of both cased and uncased transformers and chokes for use with all types of Full and Half-Wave Rectifying Tubes.

Orders filled direct from factory if dealer cannot supply you.

Set Mfgs.—Complete information and prices upon request.

Special Transformers for Trickle Chargers

Dongan Electric Manufacturing Co.
2999-3001 Franklin St., Detroit, Mich.

TRANSFORMERS of MERIT for FIFTEEN YEARS

FILAMENT AND PLATE TYPES



Famous BH Transformers Transmitting Transformers

Our transformers are ideal for low wave transmission. Watch for "BH" Announcements.

Write for Our Catalogue
Benjamin Hughes Electric Company

298 Lagachetiere St. W., Montreal, Can.
Transformer Builders Since 1910

Here is your opportunity to obtain the following bargains that cannot be duplicated. New 1 KW or 1000 Watt, 22 volt, Westinghouse generators, with pulley, ready for operation at \$48.00 each. Full 1/4 HP, 110 volt, 60 cycle, single phase, 1750 speed new motors, with cone, plug and pulley at \$10.00 each. Also, Crosley Radio Pups, new in original cartons at a special low price of \$5.00 each. Cash with order. In quantity lots \$4.50 each. Our guarantee money refunded if not satisfactory. **General Distributing Co., Security Storage & Van Bldg., Duluth, Minn.**

"CAGE ANTENNA SPREADER"

DIAMETER 7 IN.
Patented Sept. 8th, 1925

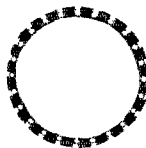

For erecting either a 4, 6 or 8 wire Cage Antenna System. Circular giving full details will be mailed upon request. Price \$4.50 per dozen; \$2.50 for a half dozen. No stamps. Immediate delivery. I pay the postage. Dealers investigate. **CHARLES F. JACOBS (RADIO 2EM)**
279 Park Place Brooklyn, N. Y.

QST

A COMPLETE TRANSMITTING KIT

Includes a hard rubber Panel, 2 condensers, RCA UX 210-7 1/2 Watt Tube, Heavy Contact Key and all other parts as specified by Q S T in April issue.

A REAL BUY

Write for our complete list.

HUDSON RADIO CO., 1416 Wythe Place, N. Y. C.

24.50

Expert Radio Operation by a turn of the Switch

REGARDLESS of make or type of receiving set Weston Model 506 Voltmeter and Universal Bi-Polar Switch on your panel will give you quick, positive knowledge of all voltage conditions on the double scale of the Voltmeter (140/7 volts).

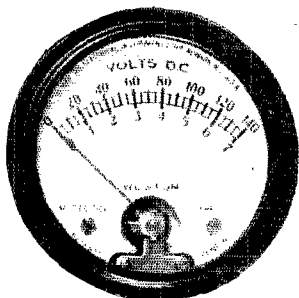

You'll use tubes at proper filament voltages, know actual battery conditions and get the best results.

Write for Circular "N" to tell you how you can get economy and radio satisfaction.

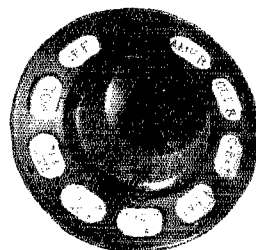

WESTON ELECTRICAL INSTRUMENT CORPORATION
158 Weston Avenue, Newark, N. J.

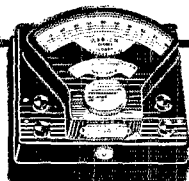

STANDARD THE WORLD OVER

WESTON

Pioneers since 1888

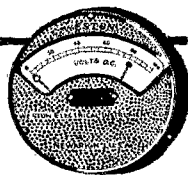

Audio Amplification

is the title of a book published by the Samson Electric Co. and available to anyone upon receipt of 25 cts.

This book contains descriptions of all methods of audio amplification such as resistance, impedance, transformer, etc., and a wealth of information heretofore unpublished.

"Audio Amplification" is considered by many engineers a manual for audio design.

Samson Electric Company

Manufacturers Since 1882

Main Offices and Factory, Canton, Mass.

Sales Offices in Thirty American Cities



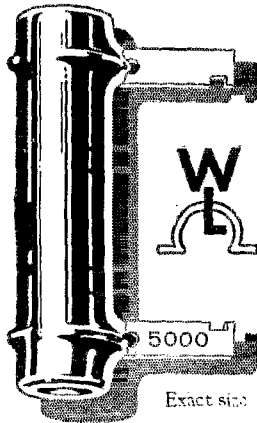

Ward Leonard
Adjustable Resistors
for building
"Raytheon" and "Amertran"
Plate Supply Circuits
(Ask for the Vitrohm Resistor Kit)

Resistors are made in small units so you can try different combinations to find the amount of resistance that gives best results in your circuit.

Useful for other radio experimenting.

There are eight units in the Vitrohm Resistor Kit, of assorted values, totalling 21,750 ohms. They are wire wound, vitreous enamelled; no carbon or graphite. Hard to break but easy to use. Handy soldering lugs. Instructions for use and mounting included.

\$8.90

Postpaid

Ward Leonard Electric Co.
Mount Vernon, New York

HERCULES
AERIAL MAST
 We pay freight
 Mail the Coupon
 20 Ft. \$10. 40 Ft. \$25. 60 Ft. \$45.
 All Steel Construction
 Complete with guy-wires etc.
 S.W. HULL CO. Dept. D 2045 East 73rd St. Cleveland, Ohio
 Please send free the full details about the "HERCULES" Aerial Mast.

NAME _____ STREET _____ CITY _____

DeForest Duo Lateral (Mounted)
HONEY COMB COILS
HALF PRICE



Just the thing for—
 —Changing wave lengths
 —Loading Coils
 —Inductance Coils
 —Wave Traps
 —3 Circuit Sets etc. etc.
 Quantity Limited! Order Now!

Number of Turns	Wave Length in Meters	List Price	Sale Price
25	360	1.40	70c
100	1485	1.65	83c
150	2100	1.70	85c
200	2875	1.75	88c
250	3650	1.80	90c
500	7600	2.20	1.10
600	10000	2.37	1.19
750	12000	2.59	1.30
1000	15000	2.86	1.43
1250	19000	3.30	1.65
1500	24000	3.85	1.93

Mail Orders Filled as Promptly as Received. Money Orders accepted Please include Postage.

DE FOREST
Radio Freq. Reflex Transformers
 List \$2.50



39c

3 for \$1.

J. Modell & Co.
31 Vesey St. New York City

QST! OSCILLATING CRYSTALS

Expert Piezo Electric Crystal Grinding done to your Specified frequency accurate to BETTER than a tenth of one Per-cent. All crystals so ground as to be capable for use in Transmitter circuits.

PRICES FOR GRINDING AS FOLLOWS.
 We will grind your crystal so as to fall somewhere in the following bands with the frequency known accurate to better than a tenth of 1%.

150—200 Meter band	\$50.00
75—85 Meter band	\$50.00
37—42 Meter band	\$50.00

Above prices include cost of purchasing a crystal for you. If crystal is furnished, deduct \$5.00 from the above prices.

BROADCAST STATIONS

We will grind for you a crystal to your assigned frequency accurate to better than a tenth of one Per-cent for \$50.00, which includes cost of purchasing crystal for you. Crystals ground to any frequency between 50 and 10,000 Kilo-cycles, and all Crystals guaranteed. Prompt Deliveries.

SCIENTIFIC RADIO SERVICE

Box 86 Dept. C Mount Rainier, Maryland

\$1.50 lower half \$2050 Receiving Set consists of three Rhoads, 1 three pole double throw Cam Switch, 1 D Coil Variometer, binding posts, gang pin jack, aluminum socket brackets, 1-3 gang standard sockets on shock absorbers. We bought \$10,000.00 worth of United States Government Department Radio Transmitting Receiving Sets and Parts. Get our new and latest reduced price list for a 2c s-amp. Mail orders sent all over the world.

WEIL'S CURIOSITY SHOP
20 South 2nd St., Philadelphia, Pa.



Your New Set

Should be equipped with regulating instruments
 Send for Jewell's New Radio Catalog—15-C
JEWELL ELECTRICAL INSTRUMENT CO.
 1650 Walnut St. - Chicago
 (26 Years Making Good Instruments)

THE SUPER-SYNC

The Synchronous Rectifier That Can Be Filtered

The Super is the only synchronous rectifier that gives a pure D. C. tone with ordinary type of filter. This rectifier is adaptable to both high and low power transmitters as it easily handles up to 4000 volts.

The commutator on the Super is eight inches in diameter and by reason of its large diameter it can handle higher voltages without breakdown.

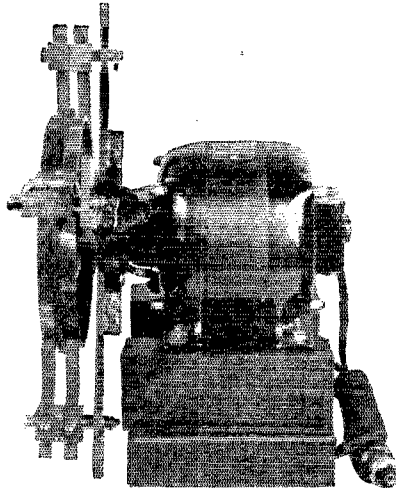

Eight brushes mounted in pairs ninety degrees apart serve to conduct the current. These brushes are mounted on a rocker arm so that they can be adjusted for proper commutation.

The commutator is turned at a synchronous speed by a $\frac{1}{4}$ H.P. 1800 R.P.M. synchronous motor. This motor can be supplied for either 110 or 220 volts 50 or 60 Cy.

PAT. PENDING

PRICE \$75.00 F. O. B. ST. LOUIS

MARLO ELECTRIC CO., 5241 Botanical Ave., St. Louis, Mo.

for Modern Radio-Set Construction

The National Tuning Units

BROWNING - DRAKE Radio-Frequency Transformers: with their scientifically computed coil-constants,—product of Research of G. H. Browning and F. H. Drake, at Harvard University.

Coils space-wound with enamel wire,—made to withstand rough handling without damage or alteration of characteristic, yet shows lowest R.F. resistance recorded for coils of this type.

Mounted with each coil,—a NATIONAL "EQUI-CYCLE" Condenser, giving true straight-line frequency, spread out over three-quarters of a turn. The plate design was developed by G. H. Field of Harvard University, and Carl Hellman of Washington, D. C.

And for tuning control, the NATIONAL VELVET VERNIER Dials, Type B,—giving velvety, even movement of condenser shafts with variable reduction ratio of from 5-1 to 20-1.

These NATIONAL Radio set essentials, with the required sockets, panels, rheostats, etc., are easily assembled into a modern broadcast receiving set:—sensitive, selective and simple to operate.

Be sure you get genuine NATIONAL products.

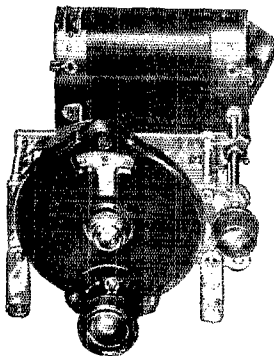

BD-2B

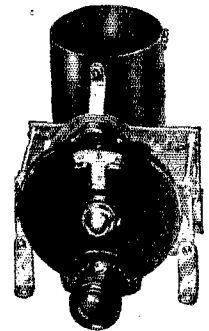

BD-1B

NATIONAL CO., Inc. Engineers and Manufacturers

W. A. Ready, President

110 BROOKLINE STREET

CAMBRIDGE, MASS.

FROST-RADIO

Type 700 Metal Frame Rheostats

To meet the requirements of new tubes an entirely different type of metal frame rheostat has been designed by **FROST-RADIO** engineers to give perfect output (volume) as well as filament control. Supplied in resistances from 2.5 to 75 ohms. Bakelite pointer knob; smooth acting lever; carries 25 to 50% overload without overheating. Ask your dealer to show you these new models. List: 50c.

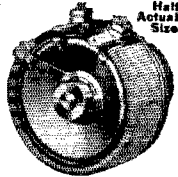

HERBERT H. FROST, Inc.

160 North LaSalle Street Chicago, Illinois
New York City Los Angeles

Roller-Smith Co., Hot Wire Ammeters

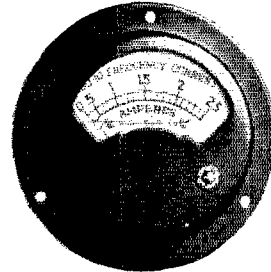

Flush Model,
3½" Diameter,
Zero Adjuster
in front.

NEW and ACCURATE

0-1 Amp. \$4.25 ea.

0-2.5 Amps. \$3.25 ea.

List Price \$13.75 each
American Sales Co. 21 Warren St., N. Y. C.

To Our Readers Who Are Not A. R. R. L. Members

Wouldn't you like to become a member of the American Radio Relay League? We need you in this big organization of radio amateurs, the only amateur association that does things. From your reading of *QST* you have gained a knowledge of the nature of the League and what it does, and you have read its purposes as set forth on page 6 of every issue. We would like to have you become a full-fledged member and add your strength to ours in the things we are undertaking for Amateur Radio, and incidentally you will have the membership edition of *QST* delivered at your door each month. A convenient application form is printed below—clip it out and mail it today.

.....1926

American Radio Relay League,
Hartford, Conn., U. S. A.

Being genuinely interested in Amateur Radio, I hereby apply for membership in the American Radio Relay League, and enclose \$2.50 (\$3 in foreign countries) in payment of one year's dues. This entitles me to receive *QST* for the same period. Please begin my subscription with theissue. Mail my Certificate of Membership and send *QST* to the following name and address.

.....
.....
.....

Station call, if any

Grade Operator's license, if any

Radio Clubs of which a member

Do you know a friend who is also interested in Amateur Radio, whose name you might give us so we may write him about the League?

..... Thanks!

SAY YOU SAW IT IN Q S T—IT IDENTIFIES YOU AND HELPS Q S T

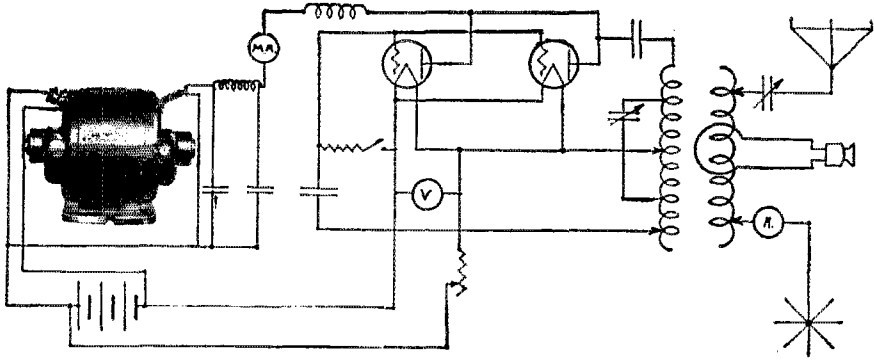

ELECTRIC SPECIALTY COMPANY

Manufacturers of Motors, Generators, Motor-Generator Sets, Dynamotors and Rotary Convertors for all Radio purposes. Have you got your copy of Bulletin 237B and ESCO Filter facts? If not, write for them.

TRADE 'ESCO' MARK

225 South Street,

Stamford, Conn.

"ESCO" Engineers will help you solve that Generator problem

The small capacity and inductance values used for shortwave reception, require exceptional strength of structure and accuracy in the manufacture of the condensers and coils.

Hammarlund precision methods were never better exemplified than in Hammarlund Short-Wave Condensers and Coils.

Hammarlund Condenser frames are rib-reinforced aluminum alloy. The plates are hard brass, supported by tie-bars. They will not warp or get out of line.

Hammarlund Space-Wound Coils are permanently anchored in a film of dielectric, which has practically no electrical effect, but adds materially to their strength.

Hammarlund offers you the most durable and accurate short-wave condensers and coils available.

Write for Literature

HAMMARLUND MANUFACTURING CO.
424-438 W. 33rd Street, New York City

Hammarlund
PRECISION
PRODUCTS



THE OLD MAN SEZ:

When your sigs are weak and lack the kick,
And the DX rolls in like a ton of brick,
And you've called in vain till you're nearly sick,
Then try a few new parts to turn the trick.

AND

DONT FORGET

You can get the stuff from Old Man Nick.

(Joe)

Joe has sure got the right dope for we carry a full line of Ham transmitting and receiving parts. And before you forget it drop us a line for our Catalogue A-2.



NICHOLSON ELECTRIC CO.

1407 First North St., Syracuse, N. Y.

The
why ADVANCE
"SYNC"
RECTIFIER

is preferred by amateurs all over the world

1. The ADVANCE Sinc Rectifier actually does what any other rectifier claims to do.
2. Can be easily and quickly filtered.
3. Meets all requirements for heaviest duty.
4. Speedy starting because of Advance Bakelite wheel.
5. Requires no attention—always ready.

Its prevailing use in international transmitting is evidence that, although lower in price, the advance Sinc Rectifier is superior in quality.

Revolving disk is moulded bakelite six inches in diameter. Nickel plated brush holders with adjustable gauze copper brushes. Convenient control handle. Disk, aluminum brush arm support and brush holders perfectly insulated.

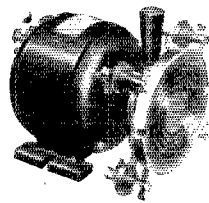

Price complete with Westinghouse 1/2 H. P. Synchronous Motor \$40
Rectifying wheel with complete brush assembly and mounting ring to fit your own motor \$15

We Pay All Transportation Charges in U. S. A.
ADVANCE ELECTRIC COMPANY
1260-1262 West Second St., Los Angeles, Calif.

CARTER

"HI-OHM" Universal Volume Control
For All Circuits



(PAT. PEND.)

\$2

500,000
OHMS

HALF SIZE

The resistance element produces a uniform percent change. At zero the resistance rises slowly. Near the maximum end the resistance rises more rapidly, but always at the same percent change. It is correct for all circuits. The Carter "HI-OHM" allows closer regulation near zero than the ordinary 200,000 ohm control. It is therefore no longer necessary to purchase lower resistance controls to get good regulation at the zero end. "HI-POP"—same design and construction in Potentiometer form, \$3.25.

Write for folder of diagrams etc.



Any dealer can supply

In Canada — Carter Radio Co., Limited, Toronto



**Transmitters—Receivers
Wavemeters**

The New E-R-L Master Oscillator Unit can quickly be adapted to most types of Transmitters. Can be supplied for any Power Rating and will assure you of a steady Wave on Short Wave Transmission. Details on Request on this and other E-R-L Quality Products. Services on all Radio Equipment, Wavemeters, Transmitters, Receivers, Broadcasting, or Amateur, Master Oscillator Transmitters, Power Controls Panels, Speech Amplifiers, Microphone Input Controls, etc. Any Power Rating.

See Quotations on Request. Your Parts Included if desired.

ENSALL RADIO LABORATORY

1208 Grandview Ave.

Warren, Ohio

"The Pioneer Builders of Short Wave Equipment"

AMATEUR

BROADCAST

COMMERCIAL

RADIO OPERATORS WANTED

THE EASTERN RADIO INSTITUTE can train you quickly and thoroughly because:

MODERN AND EFFICIENT METHODS

THOROUGH INSTRUCTION under staff of

LICENSED COMMERCIAL OPERATORS

MODERN APPARATUS including SHORT WAVE

TRANSMITTER

FOURTEEN years a RADIO SCHOOL

THE OLDEST, LARGEST and MOST SUCCESSFUL

school in New England. RECOMMENDED BY THE

A. R. R. L.

Day or Evening Classes Start Every Monday.

SPECIAL CODE CLASSES

Write for Illustrated Prospectus

EASTERN RADIO INSTITUTE

899 BOYLSTON STREET BOSTON, MASS.

30% OUTPUT INCREASE SINCE REL TRANSMITTING INDUCTANCES

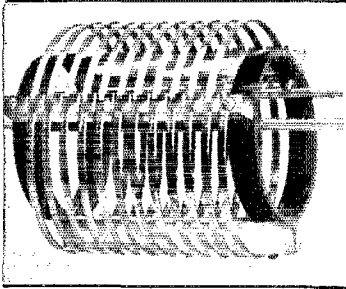

HAVE BEEN INSTALLED AT THE PRINCIPAL U. S. ARMY AMATEUR NET STATION 2 CXL FORT MONMOUTH, N. J. THIS STATION, PROBABLY, DOES MORE CONSISTENT DX WORK THAN ANY OTHER ONE OPERATING WITHIN THE AMATEUR BANDS.

Flatwise Wound Low Distributed Capacity
Insulated with Crystal Glass Spacers

For all circuits using any power from 1 to 1000 watts

Type "L"-5" dia-11 $\frac{1}{2}$ turns—for 40-80 and 150 meter bands

Type "S" 3" dia-11 $\frac{1}{2}$ turns—for 20 meters and lower

Single units with 3 clips . Price \$5.50

Two units with glass coupling rods - Price \$11.00

Priced slightly higher west of the Rockies

RADIO ENGINEERING LABORATORIES
27 THAMES ST., NEW YORK, N. Y.

THE SIGNAL SCHOOL



Office of
Radio Division

7.8472
FORT MONMOUTH, N. J.
June 7, 1926.

Mr. FRANK A. Dunbar,
Radio Engineering Laboratories,
27 Thames Street,
New York, N. Y.

Dear Mr. Dunbar,-

Your letter of June 2, 1926 regarding the REL inductance received.

We have completed the installation of the coils on the 60 meter set and secured an increase of one ampere in antenna current and an increase of two amperes in the closed oscillating circuit of the master oscillator.

Have had no time to get photos of this work or to tackle the 40 meter set yet but expect to finish this work in about two weeks. We will then send you complete data and photographs.

Yours sincerely

Frank A. Davis
700 G. Street,
Captain, Signal Corps
Liaison Agent.

The World's Greatest Bug

Improved Martin

Reg. Trade Marks
Vibroplex
Bug
Lightning Bug

VIBROPLEX

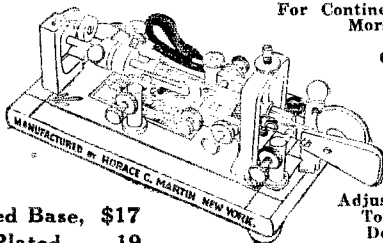

For Continental,
Morse or
Navy
Codes

Japanned Base, \$17
Nickel-Plated, 19

Adjustable
To Any
Desired
Speed

Over 100,000 operators use the Improved Vibroplex because it is **EASIER, QUICKER** and **MORE ACCURATE** than the old key.

It transmits with amazing ease. **CLEAR, CLEAN-CUT** signals at any desired speed. Saves the arm. Prevents cramp, and enables any operator to send with the skill of an expert.

Special Radio Model

Equipped with Large Specially Constructed \$25 Contact Points. Requires no relay

Every amateur needs this bug. Easy to learn. Sent on receipt of price. Money order or registered mail. Liberal allowance on your old (Martin) Bug. Order Now!

THE VIBROPLEX CO., Inc.,

825 Broadway, New York

SAY YOU SAW IT IN Q S T—IT IDENTIFIES YOU AND HELPS Q S T



CONDENSER SERVICE FOR MANUFACTURERS

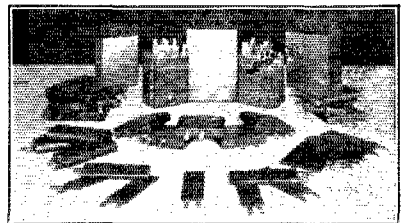

THE FARADON No. 3700 QUALITY LINE IS COMPLETE

These accurately rated high factors of safety condensers are available for manufacturers to suit individual requirements:—

- As separate units with tabs for special grouping.
- As grouped units ready for insertion in cabinets.
- As completely-cased blocks, tapped as desired.

INQUIRIES REQUESTED

Send sketch showing connections and capacities of units. Advise Flash Test and Operating Voltage requirements and space available.

QUOTATIONS FURNISHED PROMPTLY

Also By-Pass units in $\frac{1}{4}$, $\frac{1}{2}$, 1, and 2 Mfd.

WIRELESS SPECIALTY APPARATUS CO.

Jamaica Plain, Boston, Mass., U. S. A.

"It gets that last mile"

The AIRGAP SOCKET

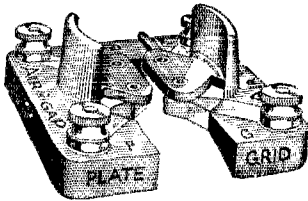

THE NEW
U. X.
UNIVERSAL
Price 60c
Lowest Capacity

AIRGAPS will help rid any set of those squawks, howls and frying noises due to socket capacity; they keep the grids negative, stabilizing the circuit, causing tube to go into oscillations more smoothly and not "spill over" until maximum results are attained.

THEY HELP PREVENT closed circuit, absorption of current, intercoupling of circuits, feedback and undesirable capacity; they make any circuit more stable and sharpen tuning, resulting in purer and clearer tones with more volume on local and distant stations.

Send Direct if Your Dealer Cannot Supply You. POSTPAID 60c EACH
AIRGAP PRODUCTS CO., MFR.
13 Campbell Street, Newark, New Jersey

The AIRGAP SOCKET

"It gets that last mile"

WARD LEONARD Transmitting Resistances NEW VITROHM RESISTOR KIT

Each kit contains the following resistances:
1-750 ohm—3-1500 ohm—1-3000 ohm—3-3500 ohm
2-5000 ohm.

Special Sizes

Mailed Free Every Month! "Broadcasts", a monthly publication devoted to new things in radio. Send in your name.

SPECIAL SERVICE
to A. R. R. L. Members.

Write for Full Particulars

MORISON
Electrical Supply Co., Inc.
15-EAST-40TH STREET.
NEW YORK CITY

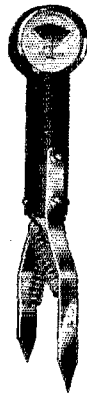

Hoyt CELLCHEK

A new, more accurate method for testing your storage battery in your radio set or car is available in the Hoyt CELLCHEK.

It uses a carefully built meter with a special scale on which you read direct whether the battery needs recharging, is low, or is in good condition. Tests under load.

Does away with hydrometer difficulties, dangers from damaged furniture, rugs and clothes and the inaccuracies due to the greatly increased care necessary to make hydrometer readings.

Tests one cell at a time,—one instrument fits all radio batteries whether 2, 4 or 6 volts. In this way a weak cell will immediately show up and it can be then separately charged to bring it up to the level of the others.

Send for new edition of catalogue "Hoyt Meters for Radio" listing many new and unique items for the radio user and enthusiast.

BURTON-ROGERS COMPANY

26 Brighton Ave., Boston, Mass.,

SEE
THAT
SCREW

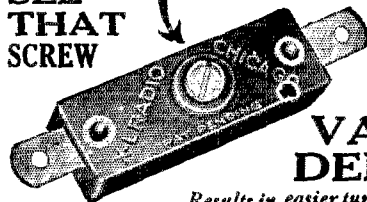

A screw driver—adjusts an X-L in crowded places.

X-L VARIO DENSER

Results in easier tuning, more distance, volume and clarity—greater stability. Indorsed by leading radio authorities.

Model "N"
A slight turn obtains correct tube oscillation on all tuned radio frequency circuits. Neutrodyne, Roberts two tube, Browning-Drake, McMurdo Silver's Knockout, etc., capacity range 1.8 to 20 micro-microfarads. Price **\$1.00**

Model "G"
with grid clips obtains the proper grid capacity on Cockaday circuits, filter and intermediate frequency tuning in heterodyne and positive grid bias in all sets. Capacity range

Model G-1 .00002 to .0001 mfd.
Model G-5 .0001 to .0005 mfd.
Model G-10 .0003 to .001 M. f. d.

Price \$1.50
X-L Push Post

Push it down with your thumb, insert wire, remove pressure and wire is firmly held. Releases instantly. Also furnished mounted on strips. Price 15c.



X-L RADIO LABORATORIES
2428 Lincoln Avenue N. Chicago, Ill.

DE FOREST TRANSMITTING TUBES 125 WATTS OUTPUT

Model C. F. 349
Filament Voltage 32 Volts, Filament Current 2.1 Amps.
Normal Plate Voltage 1500, Plate Current 200 Mills.

FINE FOR SHORT WAVE WORK

EXTRA SPECIAL \$16.⁰⁰ Ea.
American Sales Co. 21 Warren St., N. Y. C.

HAM-ADS

NOTICE

Effective with this issue of **QST** the policy of the "Ham Ad" Department is altered to conform more nearly to what it was originally intended that this department should be. It will be conducted strictly as a service to the members of the American Radio Relay League, and advertisements will be accepted under the following conditions.

(1) "Ham Ad" advertising will be accepted only from members of the American Radio Relay League.

(2) The signature of the advertisement must be the name of the individual member or his officially assigned call.

(3) Only one advertisement from an individual can be accepted for any issue of **QST**, and the advertisement must not exceed 100 words.

(4) Advertising shall be of a nature of interest to radio amateurs or experimenters in their pursuance of the art.

(5) No display of any character will be accepted, nor can any typographical arrangement, such as all or part capital letters, be used which would tend to make one advertisement stand out from the others.

(6) The "Ham Ad" rate is 7c per word. Remittance for full amount must accompany copy.

(7) Closing date: the 25th of second month preceding publication date.

FOR real pure DC notes. General Electric 24/1500 volt .283 ampere dynamotors \$45. Slightly used, guaranteed perfect \$25.00. Ideal for battery supply. \$3.00 additional for belt drive. Equally as satisfactory. Crocker-Wheeler 450 watt \$45.00. GE 12/350 volt .143 ampere with filter condenser \$18.00. Westinghouse manufacture navy short-wave receivers 50-1000 meters, high grade wavemeters, navy keys with blinker light \$2.00. Cost government \$16.50 each. Cardwell .005 condensers \$2.00, 500 cycle generators. Henry Kienzle, 501 East 84th St., New York City.

25% to 35% discount to amateurs on receiving parts. No sets. Over two pounds data, circuits catalog—25c, prepaid. Also exchange new receiving parts you want for new parts—what have you? Weekly data bulletin—\$2.50 year, trial 20 weeks—\$1.00. Fred Luther Kline, Kent, Ohio.

THE life-blood of your set—plate power. Powerful, permanent, infinitely superior to dry cells, lead-acid Bs, B eliminators. Trouble-free, rugged, abuse proof, that's an Edison Steel-Alkaline Storage, B-Battery. Upset electrically welded pure nickel connectors insure absolute quiet. Lithium-Potassium solution (that's no lie). Complete, knock-down kits, parts, chargers. Glass tubes, shock-proof jars, peppy elements, pure nickel, anything you need. No. 12 solid copper enameled permanently perfect aera wire 75c 100 ft. Make easy money with 10-battery service station charger. Details, full price list. Frank Murphy, Radio 8ML, 4837 Rockwood Road, Cleveland, Ohio.

DODGE Radio Shortcut has helped many hams—will help you. Listen to reports from licensed users:—9BNT, Creston, Iowa, says:—Thought was stung again, but tried to study and find out. At this time my speed was eight per. After three evenings with Shortcut copied twenty per easily. 9CWM, Hickman, Kentucky, says: When got right slant or your plan raised my receiving speed from about fifteen to twenty-five per in three evenings. Our method kills hesitation and cultivates legible transmission. Information and reports from other hams on request. C. K. Dodge Mamaronck, N. Y.

Notice:—After this issue, our adds appear under new name. No other change whatever. Same old quick efficient service from "the only ha mstore in the fifth district." Chemically pure sheet aluminum at .90c per square foot; and sheet lead .75c. UC490 filter condensers one mfd @ 2.50. Jewell AC voltmeters and milliameters

SAY YOU SAW IT IN Q S T—IT IDENTIFIES YOU AND HELPS Q S T

@ 7.50. Radiation ammeters 12.00 with plenty of sizes on all types. No. 12 enamelled antenna wire 1.00 per hundred. Full line of General Radio plug-in coil hardware. Write us for price list, it's free. Fort Worth Radio Supply Co. Operated by "Harris" 5RM, Ft. Worth, Texas.

RADIOMEN—Send for our radio catalog. 25% discount to hams. Radio Specialty Shop, 525 Park Avenue, Kent, Ohio.

49c TRANSMITTING rheostats for 5-7.5 watt tubes. 3 for \$1.25. New VT2 tubes \$4.50. Joseph Neubauer, 1220 Pine Street, Philadelphia, Pennsylvania.

SPECIAL sale one 500 volt, 350 watt Lincoln generator—\$15.00; one General Electric 1/2 h.p. motor—list \$45.—sacrificed for \$25.00; one General Electric 1500 volt dynamotor practically new with shaft extension—\$23.00. All the above is guaranteed in excellent condition. 9CAV.

500-5000 Treco tuner—best offer, 650 v. mounted transformer \$5.50, 500 v. generator \$18. 9BRL, Carthage, Illinois.

BETTER Edison elements, welded connections 7c pair. Sample cell 10c. Paul Mills, Woodburn, Oregon.

EXCHANGE—500v mg, new 250w Mueller tube, Mig-non long wave receiver. Want 1000v mg or cash. Walleze, 597 N. James, Hazelton, Pennsylvania.

PRICES TALK: RCA UC1846 \$1.00 each UC1803 50 cents UC1014 \$2.25 All Jewell meters 20% off list price. R.E.L. short wave plug in coils \$3.95 R.E.L. double transmitting inductances \$9.95 single units \$4.75 Cardwell .0005 condensers \$1.25 Cardwell (rebuild) double spaced transmitting condensers \$3.50. New Hammarlund SLF condensers .0001, .00014, .00025 mfd \$3.65. RCA UX210 \$6.95 Marco Vernier dials \$1.65 Aero short wave plugin coils \$9.95 Brass telegraph keys, heavy silver contacts \$2.50. 2BDZ 153 Schenck Avenue, Brooklyn, New York.

WRITE for money saving list on radio parts. 9BLE.

READ em and weep: Thordarson 650 volt combined plate and filament transformer for 5 and 7.5 watters \$6.50. All other Thordarson transformers 15% off list. Jewell 0-15 AC voltmeters \$6.45. Milliammeter \$6.45. Thermo-couple ammeters \$9.95. Pyrex strain insulators 7 1/2" \$1.20. 12" \$2.75. Lead-in bowls \$1.20. Crescent lavite 5000 ohm transmitting grid-leaks \$2.25. Power rheostats 2 ohm 5 ampere \$3.00. Lots of other bargains, send for list. 2 MA 207 Neptune Ave., Brooklyn, New York.

Will trade Typewriter and Superhet kit for Dynamotor, meters, etc. Kirk Taylor, Loraine, Texas. 5AHX.

WANTED Cardwell transmitting condensers. Weston meters, vibroplex, filter condensers. E. A. Lawton, Plymouth, Illinois.

NEW tubes—UV203A, 50 watters \$19.50, Amrad S tubes 4000-1 \$5.00, one UV204 used but OK \$25.00. H. C. Wing, Greenfield, Mass.

EDISON six volt 37 ampere battery ten dollars cost fifty. Hundred cell Edison B new cheap. N. Holt, East Aurora, N. Y.

FOR sale, 2 UV203As new \$28. each, or will trade one for monigraph number two. Make your offer at once. Mitchell Jowdy, Washington, North Carolina.

ABSOLUTELY complete 100 watt outfit sacrificed. 2AQW.

1000 OMNIGRAPHS wanted. "S" tubes, transmitting tubes, transformers, chokes, vibroplexes, receivers, transmitters, bought, sold. 9CNS, L. J. Ryan, Hannibal, Missouri.

UC1015 condensers in original cartons. A dollar bill while they last. H. N. Walker, 1335 Lafayette Building, Detroit, Michigan.

500 CYCLE alternators for plate excitation and other army air service equipment. Robt. B. Bridge, 2412 Main Ave., San Antonio, Texas.

WANTED—motor generator. 110 volt 60 cycle—1000 volt generator. Good condition and priced right. 6ANQ.

WHEN YOU REBUILD—Thordarson 650-volt Power filament Transformers for 5-watters \$6.90. Curtis-Griffith 250-watt power-filament transformers 350-550 each side \$10.50. Jewell O-15 AC voltmeters \$7.50; O-500 Milliammeters \$7.50. Gridleaks \$1.60. Aluminum square foot 86c; Lead square foot 86c. Thordarson power transformers 350-550 each side \$9.95; 1000-1500 each side \$15.00; 80 watt filament transformers \$6.00. Edgewise Wound Copper Strip, 6-inch size per turn 12c; 4-inch per turn .10c. Bakelite sockets 13c. Porcelain Insulators 20 for 50c. 5-Plate Condensers 49c. "Ham-List" 4c. Service—That's me. James R. Curtis, 1109 Eighth Avenue, Fort Worth, Texas.

FOR sale—DeForest OT3 complete with 2 tubes and mike. Best offer takes it. Have a heart fellows. Ed Anderson, 8120 Escanaba Ave., Chicago, Illinois.

WANTED—Omnigraph. Must be cheap. Bernard Taylor, Thornton, Texas.

Lopez Special short-wave coupler. Bremer Tully short-wave coupler. Jewell O-10-A.C. voltmeter. Kellogg microphone. Thordarson 80 watt power transformer. Amplifying transformers. Large marble base Signal key. Would like a Vibroplex. Make me an offer u9DSQ.

ESCO motor generator five hundred volts, two hundred and fifty watts, fifty dollars, practically new. 9ELL.

WAVEMETERS, 10 to 100 meters, two coils, individually calibrated. Accuracy guaranteed within one percent. Excellent construction and handy size, with flash lamp. \$12.50. Short-wave Coils, set of five celluloid supported space-wound plug-in coils with mounting for that new receiver. 18 to 250 meters, \$4.00. We build real amateur equipment and carry the supplies you need. Send for list. Howard F. Mason, 7BU, 3335 33rd Ave. South, Seattle, Washington.

Jewell meters 25% discount. We specialize on parts and carry a complete line of ham transmitting and receiving apparatus in addition to regular broadcast equipment. We carry in stock products of the best nationally known manufacturers, such as Acme, National, General Radio, Thordarson, Raytheon, Philco, Nathaniel Baldwin, Radio Engineering Laboratories, Cardwell, Allen Bradley, Tobe Deutschmann, Kellogg, Centralab, Yaxley, Acme Wire Company, Crescent Radio Company, M. M. Fleron, Aero Products, Inc. Tell us what you want. We allow discounts to A.R.R.L. members and dealers only. Give your call letters. Roy C. Sturge, Wholesale Radio, Montgomery and Burt Sts., Syracuse, N. Y.

FOR sale—Acme 200 watt power transformer. 11 bucks. 2-1 mfd. 1750 volt Faradons at \$1.75 Acme 3 henry half ampere choke \$2.00. B-T 11 plate condenser \$3.00. All American 10 to 1 transformer, \$3.00. All guaranteed perfect. Drew D. MacDougal, Nichols, Iowa.

NEW G. E. 500 volt 100 watt generator. First \$20 takes it. Wm. F. Miller, Box 858, Riverhead, N. Y.

Curtis-Griffith "Curgri-Co" or Roice 5-watt DX Babies \$3.15 post-paid. Mueller 150-watt input power tubes \$15.00 socket FREE. (Dealers wanted). Want used 50-watters, bugs. "Ham-List" 4c. Price Griffith, 1109 Eighth Avenue, Fort Worth, Texas.

SELL Bremer Tully amateur low wave tuner, \$8.00. Write to Radio 9DDP, Gresham, Nebraska.

PURE aluminum and lead rectifier elements, holes drilled, brass screws and nuts, pair 1/16", 1" x 4", 13c, 1 x 6 15c, 1 1/2 x 6 17c, 1 1/2 x 6 19c. Sheet aluminum 1/16" \$1.00, 1/8" \$1.90. Lead \$1.00 square foot all prepaid. Silicon transformer steel cut to order .014", 10 lbs. 25 cents, 5 lb. 30 cents, less than 5 lbs. 25 cents per lb. 4 cubic inches to the lb. Postage extra. 1/2 cash with order—balance C.O.D. Edgewise wound copper ribbon .350" wide; 3/4" outside diameter 10c turn, 4/4" 13c turn, 5/4" 15c turn, 6/4" 17c turn, 7/4" 20c turn, prepaid. Geo. Schulz, Calumet, Michigan.

THERE'S one guide to dependable Ham merchandise, 9ALD's HAMALOG, the original Ham Catalog. Customers in every part of the world, and thousands in this continent, use it regularly. Why not you? We'll send it free. You'll find it simply impossible to obtain as complete a line anywhere else. Such lines as National, Acme, Faradon, Allen-Bradley, Belden, Pyrex, Fleron, Goodrich, Thordarson, General Radio, and many others, don't need recommendation—you know the quality. By the way, we have a new Signal high pitch buzzer, a peach, for only \$1.10. Discounts to bona-fide dealers. Give references. E. F. Johnson, 9ALD, Waseca, Minn.

FILTER chokes unmounted 20H 25 M.A. \$1.00—30 H 50 M.A. \$1.50—50H 60 M.A. \$2.00. 275V transformer from 110 \$2.00. Use two for Raytheon tube, 420V secondary with midtap and 8V primary with midtap from 110 mounted \$4.00. All prepaid three zones. Write for list of other parts. M. Leitch, 32 Park Drive, West Orange, N. J.

10 WATT transmitter for sale. Complete with 500 v. Escro. R. J. Mumaw, 701 Walnut Ave., Scottdale, Pennsylvania.

NEW Western Electric fifty watters \$25.00. U. C. 1014, 3000 volt .002 mfd. condensers \$1.75. D. C. to A. C. 200 watt rotary converter, \$12.00. 2BYJ.

SIGNAL variable condensers any size, .78 cents each. 9MV, Story City, Iowa.

HAM WAVEMETERS \$5.00 each postpaid. Accuracy GUARANTEED within 1/2 of 1 percent. curve chart furnished. Neat and substantial. Any amateur band, specify which. Two-band range, in cabinet, \$9.00. Edw. Bromley, Whitewater, Wis. 9CSM.

Tube transmitting condensers (tested) 1 mfd 1000 volts \$1.66; 1 mfd 2000 volts \$4.27; 2 mfd 1000 volts \$2.52; 2 mfd 2000 \$6.75; filter condensers 4 mfd 750 volts \$3.20; 8-watt transmitting tubes \$5.70. REL low wave coils for 20, 40, 80 meter wave length bands \$4.27; transmitting inductances \$5.22, double unit \$10.25. Bremer Tully three circuit tuner 200 to 565 meters with L13 condenser \$4.75; 50 to 150 meters \$3.50. Daven resistors 2500, 5000 ohms \$95; Crescent lavite resistors 50,000, 100,000 ohms \$1.45. Everything sent prepaid. M. B. Spinoza, 27 School St., Boston, Mass.

For Sale New Westinghouse double commutator 750 V, 200 W. D. C. generators direct connected to 110 V, 60 cycle A. C. motor \$45.00 Field rheostat \$4.50 each extra 25% with order balance C. O. D. Express, inspection allowed. Also other voltages and capacities. James J. Smat 1734 Grand Av. Chicago Ill.

Q R A SECTION

50c straight, with copy in following address form only: CALL—NAME—ADDRESS.

1AAP—Clifford A. Langworthy, R. D. No. 1, Westerly, R. I.

1ZA—C. E. Jeffrey, Jr., 725 Commonwealth Ave., Newton Center, Mass.

2AZU—Richard W. Pickard, 42 Clifford St., East Orange, New Jersey.

2BBC—Irwin C. Kodar, 325 East 161st St. Bronx, N. Y.

2BBW—Louis E. Walters, 22 Grattan St., Brooklyn, N. Y.

2CJD—F. G. Mackie, 424-A Fairmount Ave., Jersey City, N. J.

2MK—E. F. Raynolds, Central Valley, Orange County, New York.

4DD—Howard Mehrling, Box 585, Bartow, Florida.

5AEA—H. N. Darst, Richmond, Texas.

5AQH—H. H. Green, 6119 Bryan Parkway, Dallas, Texas.

6BBE—T. G. Hamma, 1222 E. Poplar St., Stockton, California.

7AAB—Lloyd E. Wallgren, 2124 Wetmore Ave., Everett, Washington.

SAY YOU SAW IT IN Q S T—IT IDENTIFIES YOU AND HELPS Q S T

SAGT—L. W. Clee, 2360 Flora Ave., Fairview Heights, Cincinnati, Ohio.

SHHB—John B. Trevor, Jr., McAlpin Camp, Brighton, Franklin County, New York.

SBQV—S. P. Beaman, Kenton, Ohio.

SCMY—H. S. Weber, 1113 Walnut St., Dover, Ohio.

SIX—Ex6TF Lloyd E. Furrow, 420 Lake St., Troy, Ohio.

SJB—(Ex-8BAS)—Herbert L. Gordon, 119 Riverside Drive, East, Antwerp, Ohio.

9AYO—Robert H. Layman, Bloomington, Indiana.

9CSO—C. W. Williams, Kentucky Hydro-Electric Company, Dix Dam, Kentucky.

9EDU—C. R. Waggoner, Republican City, Nebraska.

2EDN—Gaston Hebert, 1416 St. Clement St., Montreal, Canada.

23MF—Charles Howarth, 11 Fitzgerald St., St. Catharines, Ontario, Canada.

ch2AW—Otto Toelle Franke, Casilla 1201, Valpariso, Chile.

21AP—Nelson Winch, Brady Street, Te Awamutu, New Zealand.

The following stations belong to members of the A.R.R.L. Headquarters gang. Mail for them should be addressed care A.R.R.L., Hartford, Conn.

IMK Headquarters
 1AL H. P. Westman
 1BAO R. S. Kruse
 1BDI F. E. Handy
 1BHW K. B. Warner
 1ES A. A. Hebert
 1DQ John M. Clayton
 1KP F. Cheyney Beekley
 1OA R. S. Kruse
 1SZ C. C. Rodimon
 1XAQ R. S. Kruse

SAMPLES

OF OUR GREAT LOT OF
 TRANSMITTING BARGAINS

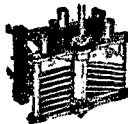

CARDWELL CONDENSERS

King-Cardwell 41-plate
 Easily double-spaced for transmitting
 King-Cardwell 11-plate
 For short wave receivers

NEW PRICE
95c
 NEW PRICE
95c

UC-1803 Faradon
 Condensers, List \$6.00
95c



UT-1367 Magnetic
 Modulator, List \$17.00
 New Price **\$3.50**

TRANSFORMERS

UV-712, \$1.60 UP-1016, \$11.50 UL-1008, \$7.50
 And others!

RCA 201 Tubes, **95c**
 UV-202 Type 5-watt Tubes, **\$3.25**
 RCA TF Transmitter, 20-watt, **\$75.00**
 Write for complete list!

RADIO SURPLUS CORPORATION
 11 STUART ST., BOSTON



What Size Grid and Plate Blocking Condensers?

You have always used .002 mfd. for blocking condensers but who knows that it is the best size for short waves? The builders of KFUH believe .000036 mfd. better for their tuned grid 'n plate circuit. Our UC 1015 condenser gives eleven different capacities between .0002 mfd. and .001 mfd. so you can select the best size for your set. Why not try them?

Price \$1.25 postpaid

General Electric Gridleaks



Brand new enameled porcelain G. E. Gridleaks in 5000 ohm and 10,000 ohm sizes for all tubes.

PRICES, 5000 ohm \$1.25, 10,000 ohm \$1.75, Postpaid.

Utility Radio Co., 80 Leslie St., East Orange, N. J.

AEROVOX

"Built Better"

RAYTHEON CONDENSER BLOCKS



AEROVOX products are used by over 200 of America's Radio Manufacturers. AEROVOX Fixed Condensers are approved by M. I. T. and Yale Universities. AEROVOX WIRELESS CORP. 489-491-493 Broome St., New York

Branch Offices:
 St. Louis, Mo., Vendome Trust Building
 Cincinnati, O., 324 P. Lane, Flaming Bldg.
 Chicago, Ill., 31 W. Jackson Bldg.
 Boston, Mass., 7, 9, 24 Portland Street
 Los Angeles, Calif., 324 N. San Pedro St.

THREE "E" STRAIGHT LINE RHEOSTAT

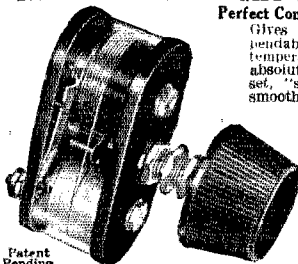

Perfect Control of Filament Temperature
 Gives you a fine, smooth, dependable variation of filament temperature. Turns smoothly, is absolutely NOISELESS, and once set, "stays out!" Controls volume smoothly, and without distortion, over the entire range. Equally efficient for short and long wave sets. By all means secure this precision instrument at once. Ask your dealer or order direct. Price \$2.50 Postpaid.

Illus.
 1 1/2 Size
 6-15-30
 Ohms

Patent Pending
ELECTRICAL ENGINEERS EQUIPMENT CO.
 Radio Division
 708 W. Madison St., Dept. 7 Chicago, Ill.
 Information on Request



Become a Radio Operator

See The World. Earn a Good Income. Avoid Hard Work.

Learn in the Second Port U. S. A.

Radio Inspector located here. Positions plentiful. Splendid Climate. Other advantages to the student unequalled in any other American port.

Nearly 100 per cent of operators graduating on Gulf during past four years trained by MR. CLEMMONS, Supervisor of Instruction. Every graduate secures position.

Day and Night Classes; enroll anytime. Write for Circular: Department TWO.

GULF RADIO SCHOOL 844 Howard Avenue, New Orleans, La.

SAY YOU SAW IT IN Q S T—IT IDENTIFIES YOU AND HELPS Q S T

Introducing the
Mar-Co
Illuminated Control
for back panel mounting

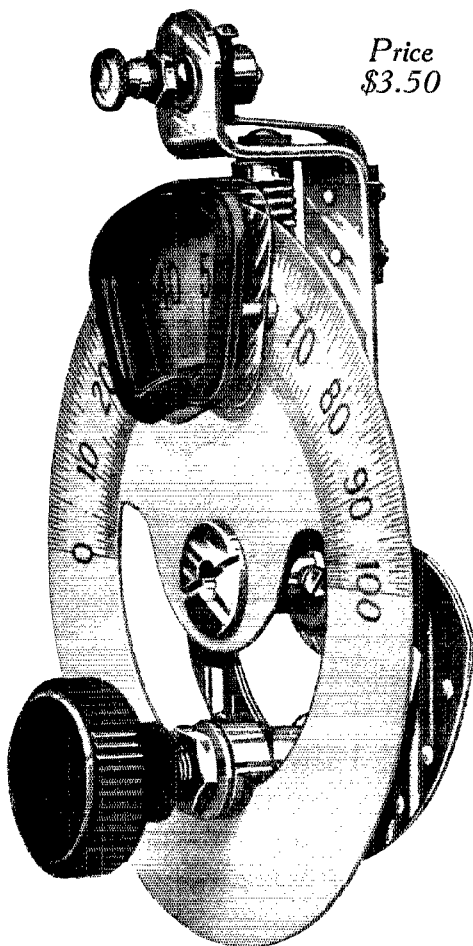

Price
\$3.50

A new and original invention for general use. Furnished with electric light and mounting accessories complete. The latest addition to the world famous line of Mar-Co 2", 3" and 4" Vernier Dials.

Write for circular

MARTIN-COPELAND CO.
 101 Sabin St., Providence, R. I., U. S. A.

FOR YOUR CONVENIENCE
QST'S INDEX OF
ADVERTISERS
 IN THIS ISSUE

Acme Wire Company	70
Advance Electric Company	88
Aero Products, Inc.	76
Aerovox Wireless Corp.	93
Airzap Products Co.	90
All-American Radio Corp.	81
Amateur Radio Specialty Co.	70
American Sales Co.	86-90
American Transformer Co.	80
A.R.R.L. Application Blank	86
A.R.R.L. Apparatus	3rd cover
Bremer-Tully Mfg. Co.	96
Burgess Battery Co.	4th cover
Burton-Rogers Co.	77
Cardwell Mfg. Corp., Allen D.	75
Carter Radio Co.	88
Central Radio Laboratory	76
Crescent Radio Supply Co.	68
Crosley Radio Corp.	88
Cunningham, Inc., E. T.	2nd cover
Deforest Radio Co.	77
Deutschmann Co., Tope	80
Donkan Electric Mfg. Corp.	82
Dudlo Manufacturing Corp.	79
Earle Radio Co.	78
Eastern Radio Institute	88
Electric Specialty Co.	87
Elkon Works	73
Electrical Engineer's Equipment Co.	93
Ensal Radio Laboratory	88
French Battery Co.	1
Frost, Inc., Herbert H.	86
General Distributing Co.	82
General Instrument Co.	82
General Radio Co.	69
Grache and Co., Inc., A. H.	4
Gross and	72
Gulf Radio School	93
Hammarlund Mfg. Co.	87
Hudson Radio Co.	82
Hughes Electric Co., Benj.	82
Hull and Co., S. W.	84
Jacobs, Chas. F.	82
Jewell Electrical Instrument Co.	84
Karas Electric Co.	71
M. B. S. Sales Co.	80
Mace and Son, F. F.	76
Magnavox Company	78
Mario Electric Co.	85
Martin-Copeland Co.	84
Modell and Co., J.	84
Morison Electrical Supply Co.	90
National Co., Inc.	85
National Carbon Co.	95
Nicholson Electric Co.	88
Pacent Electric Co., Inc.	78
Piezo Electrical Co.	72
Radio Club, Inc., The	70
Radio Engineering Laboratories	89
Radio Surplus Corp.	93
Samson Electric Co.	83
Sankamo Electric Co.	76
Scientific Radio Service	84
Signal Electric Mfg. Co.	80
Silver-Marshall, Inc.	74
Southern Toy Co.	72
Stromberg-Carlson Tel. Mfg. Co.	2
Superron Mfg. Co.	74
Supreme Supplies Co.	80
Thornderson Electric Mfg. Co.	74
Transmitting Equipment Co.	68
Utility Radio Co.	83
Vibroplex Co.	89
Ward-Leonard Electric Co.	84
Weil's Curiosity Shop	84
Weston Electrical Instrument Co.	88
Wireless Specialty Apparatus Co.	89
X-L Radio Laboratories	90
Yaxley Manufacturing Co.	68



“My wife insists on getting a radio set exactly like yours. Where did you get it?”

“THE Radio Shop put it in for us, Jim. I’ve never had anything that was less trouble or expense, or that gave us all so much pleasure. We don’t see how we ever got along without it.”

“How about batteries? I’ve heard you have to give them a lot of attention.”

“Not if you get good ones, Jim. The man who installed my set said that the Evereadys he was supplying were exactly the right size for the receiver and should last eight months or longer. I’ve had the set six months now, and as far as I can tell, the ‘B’ batteries are as good as new.”

That’s the experience of those who follow these simple rules in choosing “B” batteries for their receivers:

On all but single tube sets—connect a “C” battery. The length of service given below is based on its use.*

On 1 to 3 tubes — Use Eveready No. 772. Listening in on the average of 2 hours daily, it will last a year or more.

On 4 or more tubes — Use the Heavy-Duty “B” Batteries, either No. 770 or the even longer-lived Eveready Layerbuilt No. 486. Used on the average of 2 hours daily, these will last 8 months or longer.

Follow these rules and you, too, will find that Eveready Radio Batteries offer a most economical, reliable and satisfactory source of radio power. How long they last depends

on usage; if you listen less, you can count on their lasting longer; if you listen more, they will not last quite so long.

Send for booklet, “Choosing and Using the Right Radio Batteries,” sent free on request. There is an Eveready dealer nearby.

*NOTE: A “C” battery greatly increases the life of your “B” batteries and gives a quality of reception unobtainable without it. Radio sets may easily be changed by any competent radio service man to permit the use of a “C” battery.

Manufactured and guaranteed by
NATIONAL CARBON Co., Inc.
 New York San Francisco
 Canadian National Carbon Co., Limited
 Toronto, Ontario

Tuesday night means Eveready Hour—
 S. P. M., Eastern Standard Time, through
 the following stations:

WEAF—New York	WSAI—Cincinnati
WFAI—Providence	WTAM—Cleveland
WEEI—Boston	WWJ—Detroit
WEAG—Worcester	WGN—Chicago
WFI—Philadelphia	WOC—Davenport
WGR—Buffalo	WCCO } Minneapolis
WCAE—Pittsburgh	WCCO } St. Paul
	KSD—St. Louis

EVEREADY
Radio Batteries
—they last longer

B-T COUNTERPHASE-EIGHT

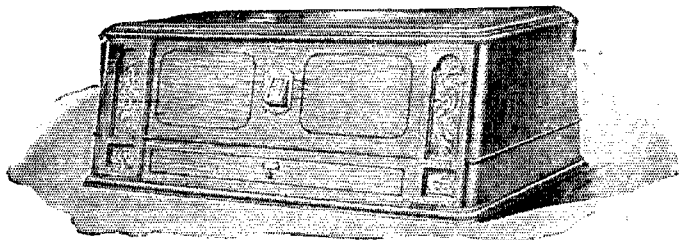

When Bremer-Tully announce a Receiver which they admit will outdo in **SELECTIVITY** any of their previous efforts, we believe all those who have followed the record of the **NAMELESS** and the **COUNTERPHASE** will be interested.

The **COUNTERPHASE-EIGHT** is simple in operation as well as super-selective. The **Rejector Stage** is something new in radio. So is the **STATION INDICATOR** a B-T patent which permits absolutely accurate calibration. Five tuned stages with power tube output.

Two main controls,—one for stations and one for volume.—**NO OSCILLATION CONTROL**,—the **COUNTERPHASE** can't be made to oscillate,—and yet it's "hot" all the way across the scale.

We certainly believe you'll like the new permanent models.

ANOTHER TRIUMPH FOR B-T EFFICIENCY



PHOTO BY WIDE WORLD PHOTOS

E. S. Strout, Jr., who claims the honor of being the first amateur to get in communication with the Byrd Expedition after the flight over the North Pole. B-T Dials, Sockets, Coils and Condensers appear in the photo.

BREMER-TULLY MFG. CO.

**532 So. Canal St.,
Chicago, Ill.**



A.R.R.L.



APPARATUS

Essential equipment for every live amateur station

AMERICAN RADIO RELAY LEAGUE LOG OF STATION							
SHEET NO. _____							
DATE	CALL	CLASS OF WORK	OPERATOR	CLASSIFICATION	REMARKS		

A. R. R. L. Log Sheets

Designed by hams for hams. 8½ x 11 bond paper, punched for standard three-ring loose-leaf binder. 125 sheets postpaid for \$1.00 or 500 for \$3.50.

Members' Correspondence Stationery

Write your radio letters on League letter-heads—it identifies you with the biggest radio organization in the world. *Lithographed* on 8½ x 11 heavy bond paper. 100 sheets postpaid for 75c or 250 sheets for \$1.70. Sold to members only.

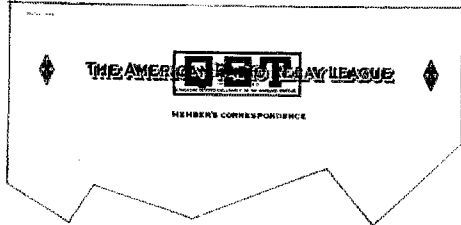

THE AMERICAN RADIO RELAY LEAGUE					
HARTFORD, CONN., U.S.A.					
RADIOGRAM					
CITY OF ORIGIN	NAME OF ORIGIN	CLASS	CLASS	CLASS	CLASS
To _____					
From _____					
Text of message _____					
Date _____					
Time _____					
Type of message _____					
Remarks _____					
Sent _____					

Official A. R. R. L. Message Blanks

Most convenient form. Designed by the Communications Department of the A.R.R.L. Well printed on good bond paper. Size 8½ x 7¼. Put up in pads of 75 sheets. One pad postpaid for 30c or four pads for \$1.00.

Message Delivery Cards

Neatest, simplest way to deliver a message to a near-by town. On U. S. stamped postals 2c each. On plain cards (for Canada, etc.) 1c each post-paid.

MESSAGE DELIVERY CARD FOR RADIOGRAM VIA AMERICAN RADIO RELAY LEAGUE	
From: _____	Date: _____
Type of message: _____	
Class: _____	All Radio Station: _____
Phone: _____	
FOR MESSAGE DELIVERY ONLY—DO NOT WRITE IN THESE SPACES	

Echoes of Byrd's Flight Over the Pole

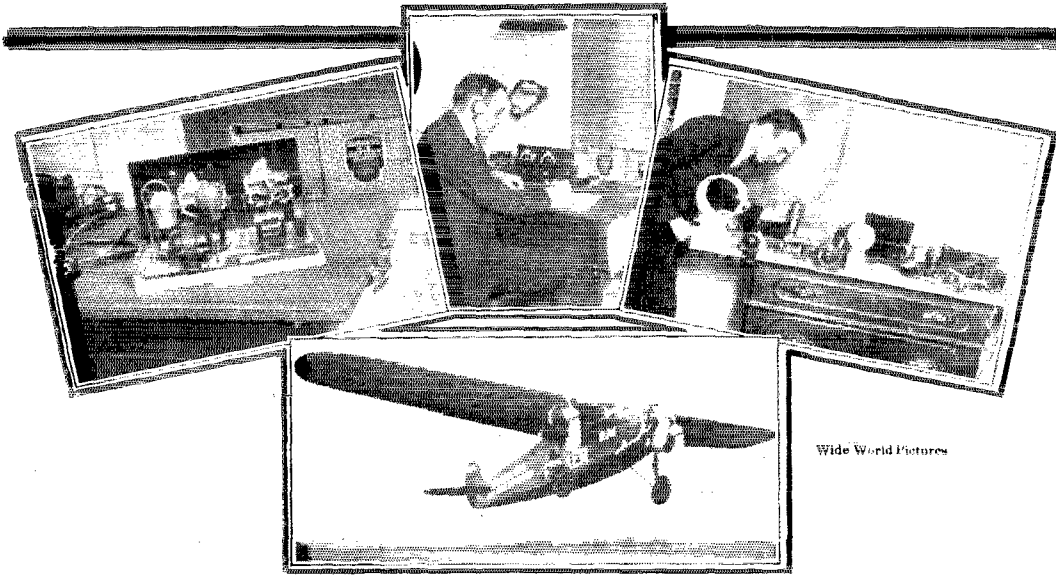

Wide World Pictures

E. S. Strout, Jr., 2NZ who worked KE6K, the S. S. Chantier, before and after Byrd's successful flight over the Pole.

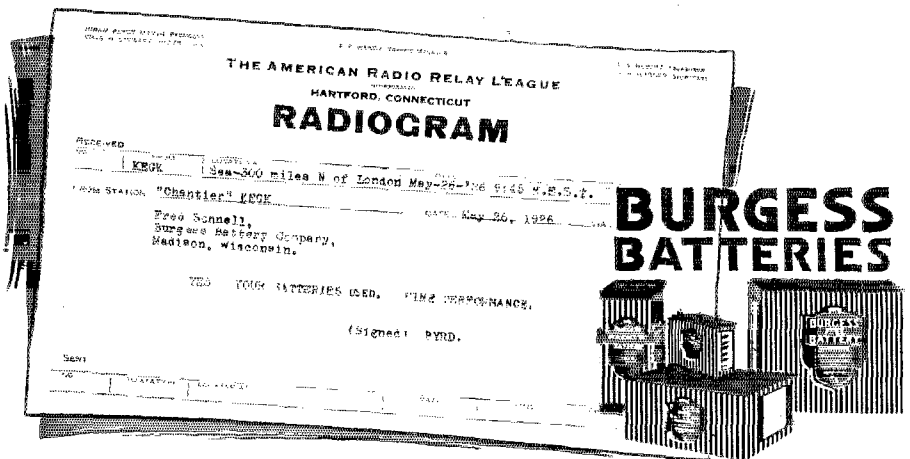

Photograph of Radiogram from Commander Byrd on board the "Chantier" to Fred Schnell of the Burgess Laboratories in reply to his question as to whether Burgess Batteries were used during the expedition.

BURGESS BATTERY COMPANY
GENERAL SALES OFFICE: CHICAGO
CANADIAN FACTORIES AND OFFICES: NIAGARA FALLS AND WINNIPEG
In United States: Offices and Warehouses in Principal Cities